

APPENDICES

Maryland Bikeways Program

University of Maryland Bike Lanes, Paths, and Trails Network & Safety Enhancements Concept Designs



April 2024

Mead
& Hunt



List of Appendices

Appendix A: Concept Plans

- Segment #1
- Segment #2
- Segment #3
- Segment #4

Appendix B: Multimodal Traffic Counts

- Count Map of Locations and Summary
- Raw Data

Appendix C: Mobility Audit Summary Chart



Appendix A: Concept Plans

- LEGEND:**
- EXISTING
 - PROPOSED
 - PROPOSED CONCRETE /SIDEWALK
 - PROPOSED GRASS BUFFER /PAVEMENT REMOVAL
 - PROPOSED SHARED-USE PATH
 - PROPOSED FULL-DEPTH PAVEMENT
 - PROPOSED REMOVAL

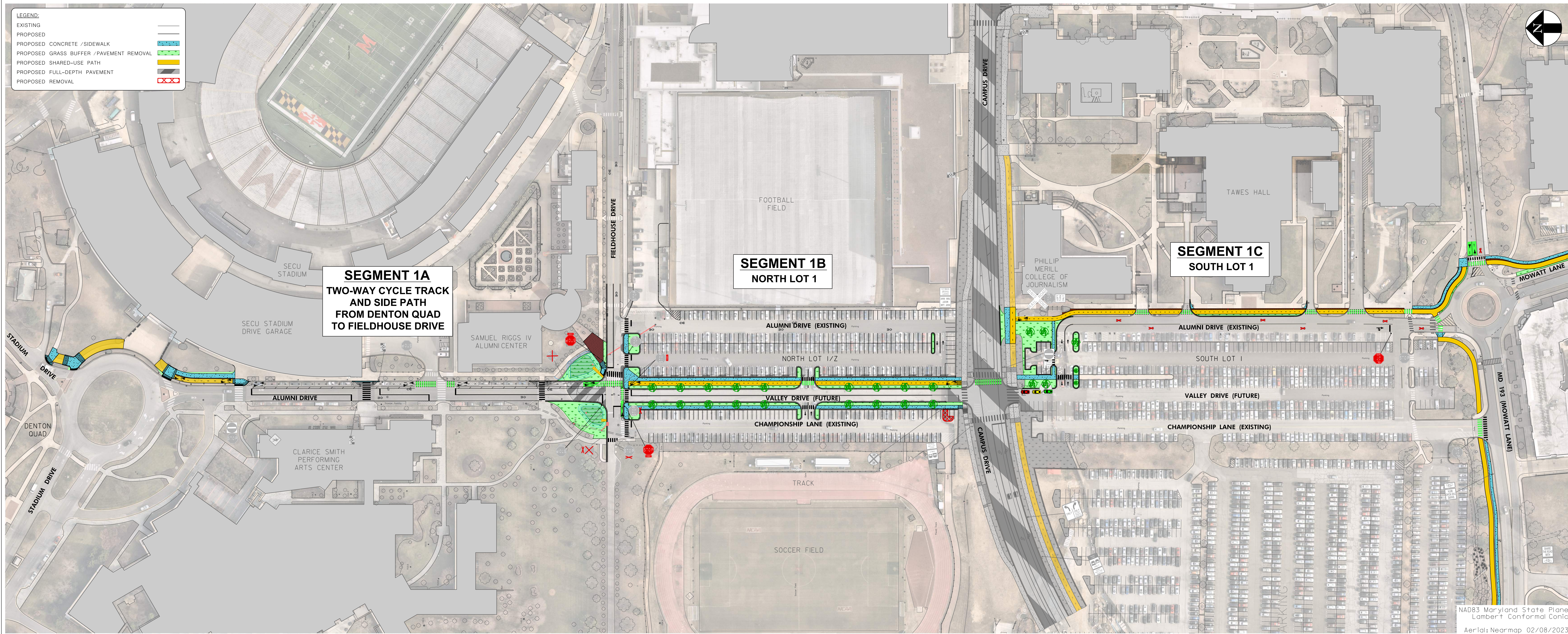

SEGMENT 1A
TWO-WAY CYCLE TRACK
AND SIDE PATH
FROM DENTON QUAD
TO FIELDHOUSE DRIVE

SEGMENT 1B
NORTH LOT 1

SEGMENT 1C
SOUTH LOT 1

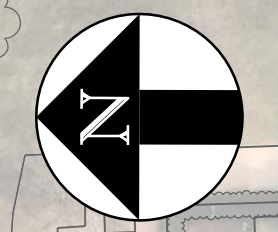

NAD83 Maryland State Plane
 Lambert Conformal Conic
 Aerial: Near map 02/08/2023

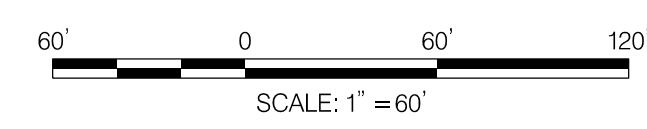

UMD Segment 1A: Two-way Cycle Track from Denton Quad to Fieldhouse Drive (Lot 1 /Z), Segment 1B, and Segment 1C

OPERA TORO2430 - PLOTTED: 03/19/24
 FILE NAME: \\corporate\meadhunt.com\shores\folders\temp\4664444\231949.01\TECH\CAD\Drawings\UMD_Segment_1_RollPlan_1.dgn

LEGEND:

EXISTING	
PROPOSED	
PROPOSED CONCRETE /SIDEWALK	
PROPOSED GRASS BUFFER /PAVEMENT REMOVAL	
PROPOSED SHARED-USE PATH	
PROPOSED FULL-DEPTH PAVEMENT	
PROPOSED REMOVAL	



SEGMENT 1E
SIDEPATH BETWEEN
MOWATT CIRCLE
AND PRESIDENTIAL DRIVE

SEGMENT 1D
SIDEPATH BETWEEN
MOWATT CIRCLE
AND KNOX ROAD

UMD Segment 1D: Sidepath between Mowatt Circle and Knox Road & Segment 1E: Sidepath between Mowatt Circle and Presidential Drive

LEGEND:

EXISTING	
PROPOSED	
PROPOSED CONCRETE /SIDEWALK	
PROPOSED GRASS BUFFER /PAVEMENT REMOVAL	
PROPOSED SHARED-USE PATH	
PROPOSED FULL-DEPTH PAVEMENT	
PROPOSED REMOVAL	

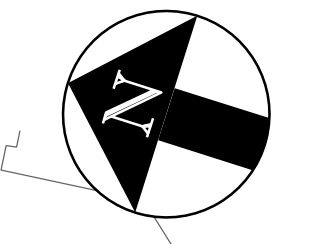
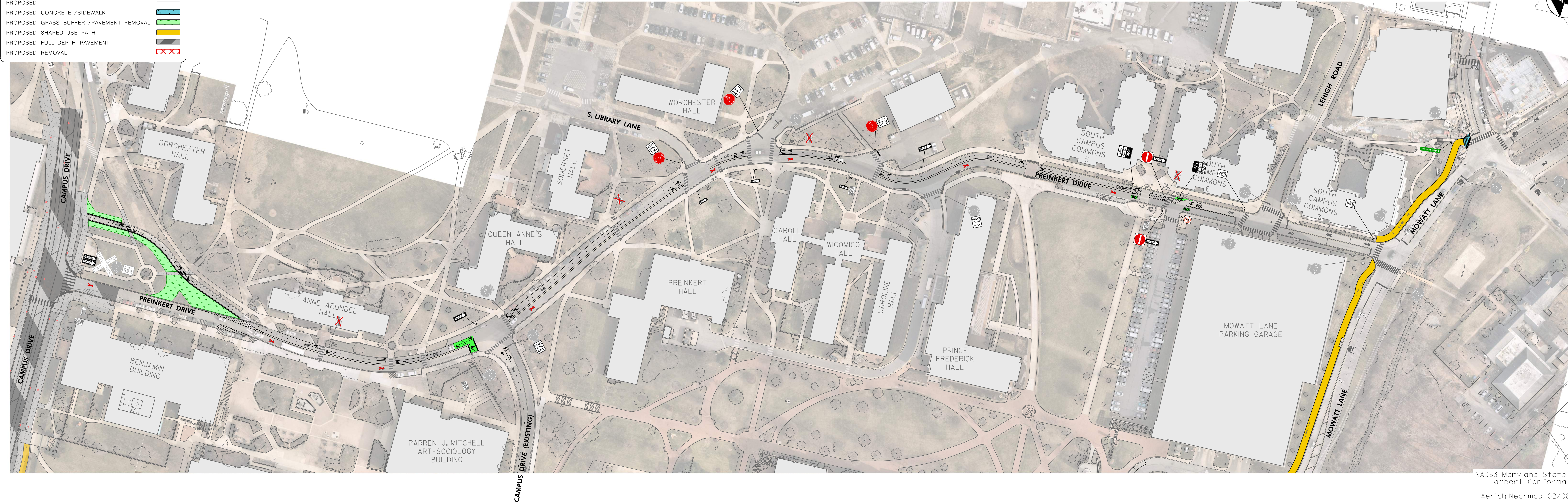

NAD83 Maryland State Plane
Lambert Conformal Conic
Aerial: Nearmap 02/08/2023

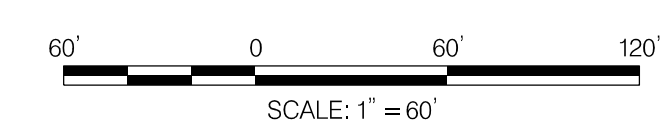







UMD Segment 1F: Preinkert Drive



OPERATOR: 03/19/24
 FILE NAME: \corp\meadhunt.com\shared\folders\enr\4664444\231949_01\TECH\CAD\drawings\UMD_Segment_1F_RollPlan_3.dgn

LEGEND:

- EXISTING 
- PROPOSED 
- PROPOSED CONCRETE /SIDEWALK 
- PROPOSED GRASS BUFFER /PAVEMENT REMOVAL 
- PROPOSED SHARED-USE PATH 
- PROPOSED FULL-DEPTH PAVEMENT 
- PROPOSED REMOVAL 



SEGMENT 2A
 SIDEPATH BETWEEN
 MD 193 / UNIVERSITY BLVD
 TO TERRAPIN TRAIL

SEGMENT 2D
 SIDEPATH OPTION
 BETWEEN
 LOT 4B AND LOT UU

SEGMENT 2C
 SIDEPATH OPTION
 BETWEEN TERRAPIN TRAIL
 AND LOT 11B

NAD83 Maryland State Plane
 Lambert Conformal Conic
 Aerial: Nearmap 02/08/2023

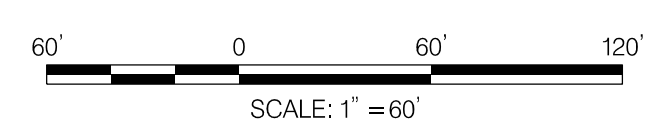

UMD Segment 2A, 2C, and 2D



OPERATOR: 03/19/24 - PLOTTED: 03/19/24
 FILE NAME: \\corp.mechant.com\shared\folders\entp_v664444\231949.01\TECH\CAD\Drawings\UMD_Segment_2_RoiPlan_1b.dgn

LEGEND:

EXISTING	
PROPOSED	
PROPOSED CONCRETE /SIDEWALK	
PROPOSED GRASS BUFFER /PAVEMENT REMOVAL	
PROPOSED SHARED-USE PATH	
PROPOSED FULL-DEPTH PAVEMENT	
PROPOSED REMOVAL	



SEGMENT 2A
SIDEPATH BETWEEN
MD 193 / UNIVERSITY BLVD
TO TERRAPIN TRAIL

SEGMENT 2D
SIDEPATH OPTION
BETWEEN
LOT 4B AND LOT UU

SEGMENT 2C
SIDEPATH OPTION
BETWEEN TERRAPIN TRAIL
AND LOT 11B

NAD83 Maryland State Plane
Lambert Conformal Conic
Aerial: Nearmap 02/08/2023

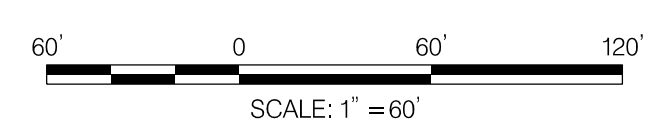

UMD Segment 2A, 2C (Alternative), and 2D

OPERATOR: 03/19/24 - PLOTTED: 03/19/24
FILE NAME: \\corp.mechhunt.com\shared\folders\entp\664444\231949.01\TECH\CAD\Drawings\UMD_Segment_2_RoiPlan_1a.dgn

- LEGEND:
- EXISTING
 - PROPOSED
 - PROPOSED CONCRETE /SIDEWALK
 - PROPOSED GRASS BUFFER /PAVEMENT REMOVAL
 - PROPOSED SHARED-USE PATH
 - PROPOSED FULL-DEPTH PAVEMENT
 - PROPOSED REMOVAL

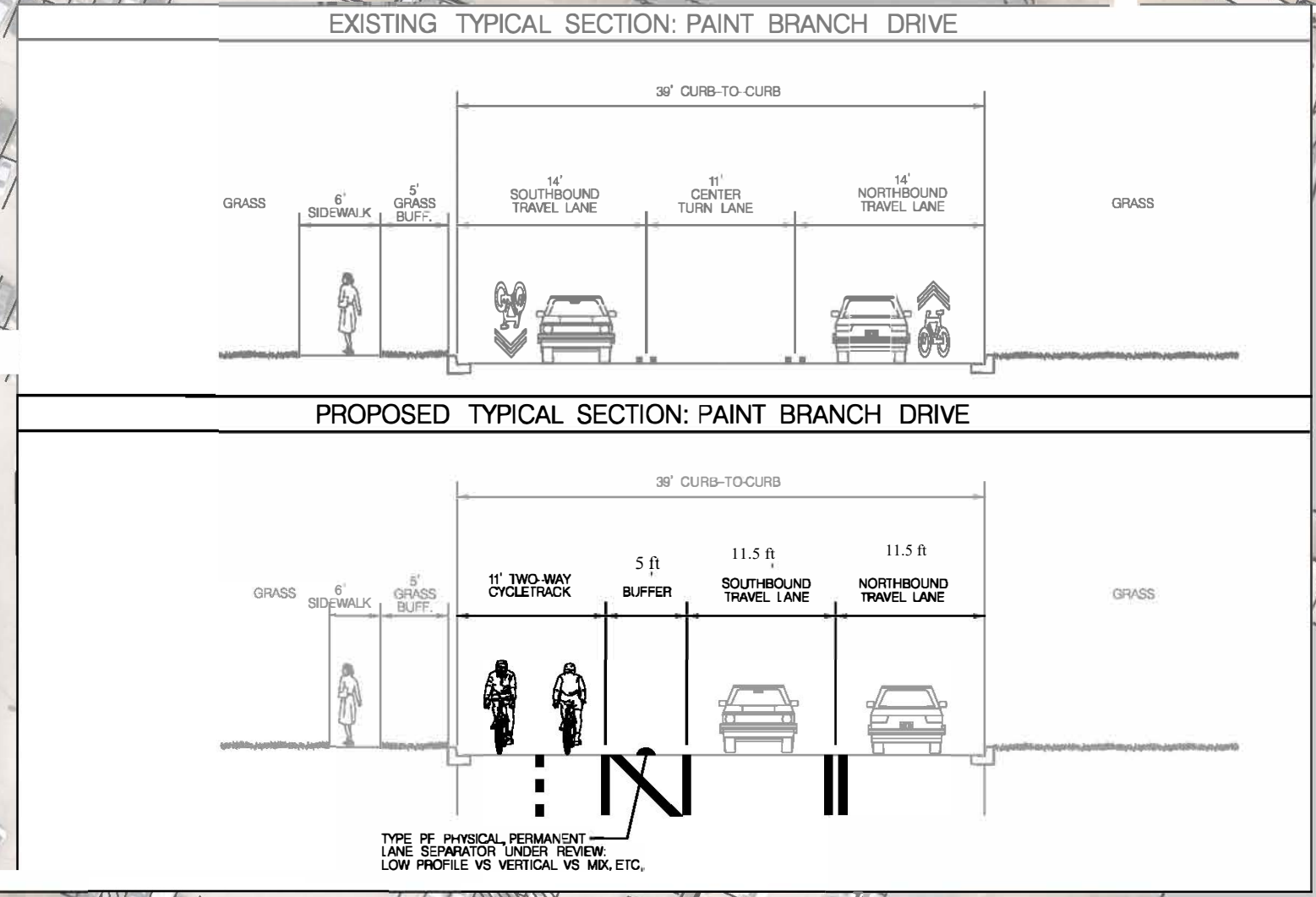




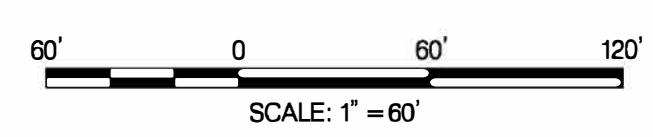



NAD83 Maryland State Plane
Lambert Conformal Conic
Aerial: Nearmap 02/08/2023

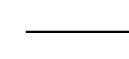

UMD Segment 2B: Interim In-road Cycle Track – Paint Branch Drive between Terrapin Trail and Regents Drive Extended



OPERATED: 03/19/24 - PLOTTED: 03/19/24 - FILE NAME: \\corp.meadhunt.com\shared\folders\mhp\4664444\231948.01\TECH\CAD\Drawings\UMD_Segment_2_RoiPlan_1c_Interim.dgn

- LEGEND:**
- EXISTING 
 - PROPOSED 
 - PROPOSED CONCRETE / SIDEWALK 
 - PROPOSED GRASS BUFFER / PAVEMENT REMOVAL 
 - PROPOSED SHARED-USE PATH 
 - PROPOSED FULL-DEPTH PAVEMENT 
 - PROPOSED REMOVAL 

SEGMENT 4A
PAINT BRANCH TRAIL
CONNECTOR TO
TECHNOLOGY DRIVE

SEGMENT 4B
PAINT BRANCH TRAIL
CONNECTOR TO
ENGINEERING DRIVE

SEGMENT 4C
PAINT BRANCH TRAIL
CONNECTOR TO
STADIUM DRIVE

SEGMENT 2E
TWO-WAY IN-ROAD
CYCLE TRACK LOOP
PAINT BRANCH DRIVE,
TECHNOLOGY DRIVE,
AND STADIUM DRIVE

SEGMENT 2F
NEW SIDEWALK, CYCLE TRACK,
AND WIDENED ROADWAY
FROM REGENTS DRIVE
RECONSTRUCTION
LOT UU TO CAMPUS DRIVE

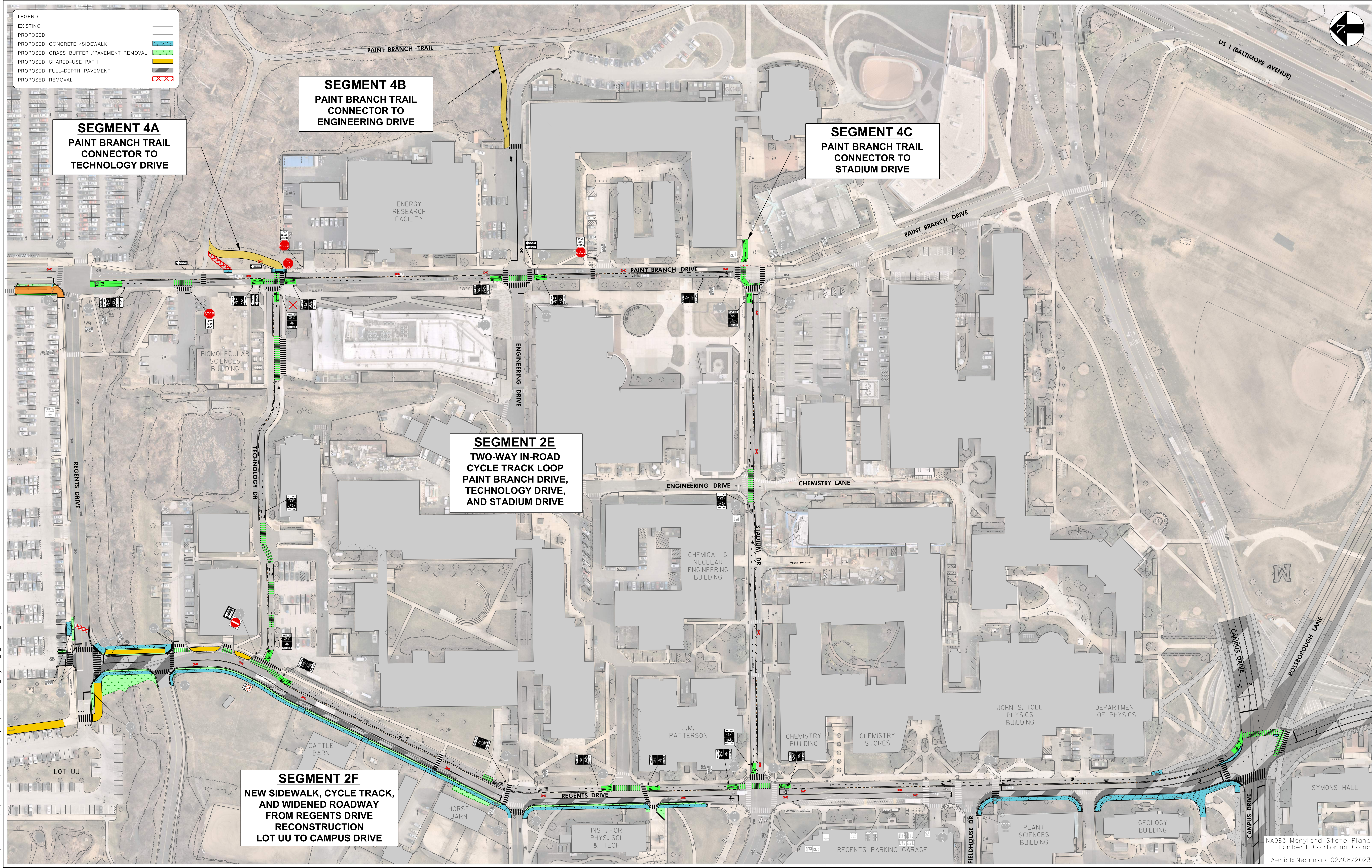

NAD83 Maryland State Plane
Lambert Conformal Conic
Aerial: Nearmap 02/08/2023



UMD Segments 2E and 2F & Segments 4A, 4B, and 4C

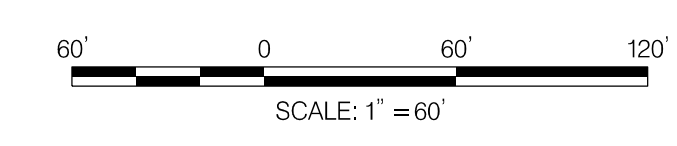

OPERATOR: 03/19/24 - PLOTTED: 03/19/24
 FILE NAME: \\corp.mechdnt.com\shared\folders\ventp\664444\231949.dwg\TECH\CAD\Drawings\UMD_Segment_2_RoiPlan_2b.dgn

LEGEND:	
EXISTING	
PROPOSED	
PROPOSED CONCRETE /SIDEWALK	
PROPOSED GRASS BUFFER /PAVEMENT REMOVAL	
PROPOSED SHARED-USE PATH	
PROPOSED FULL-DEPTH PAVEMENT	
PROPOSED REMOVAL	

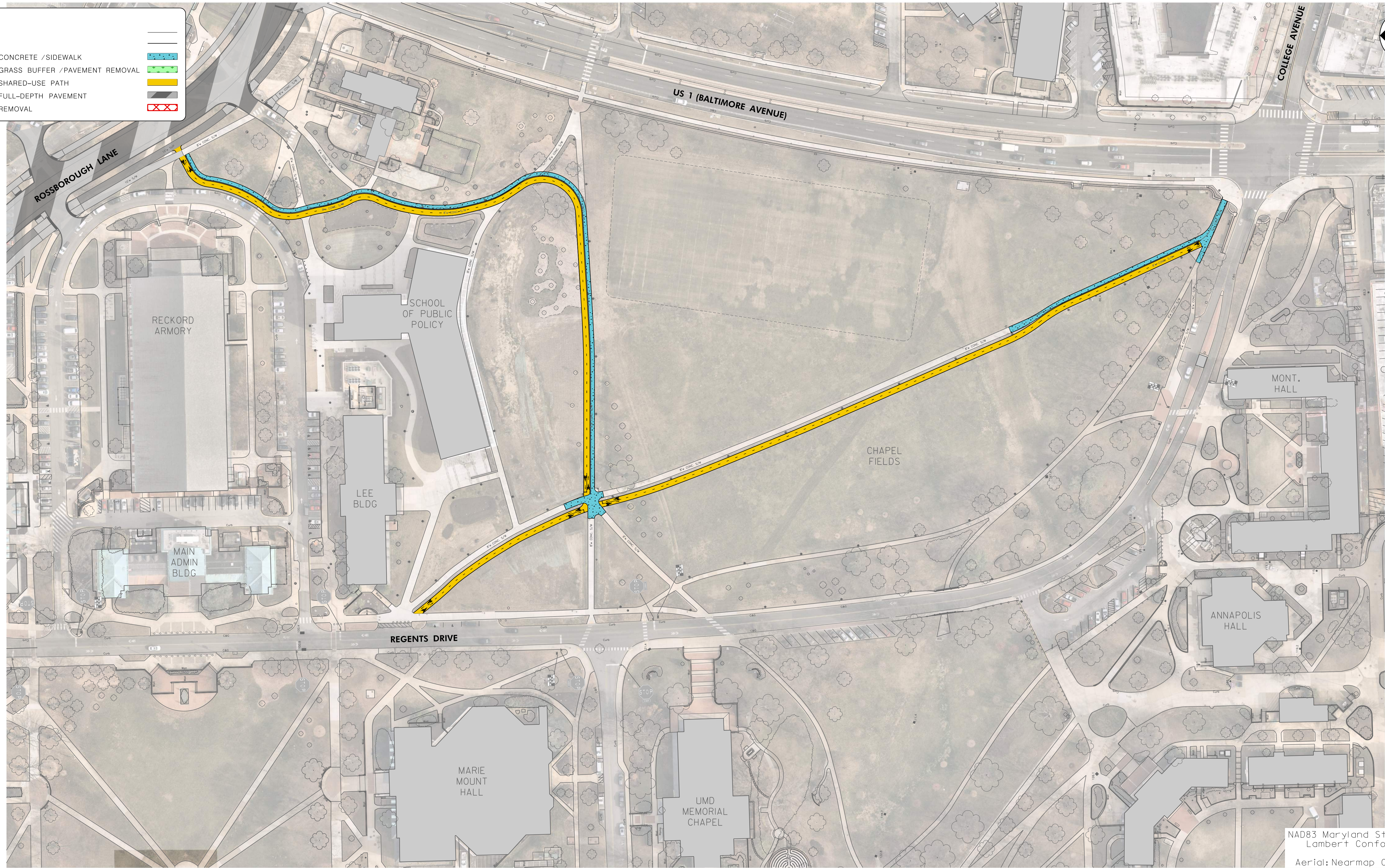
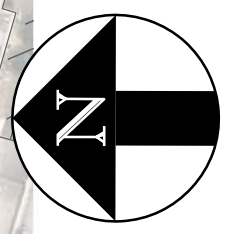

NAD83 Maryland State Plane
Lambert Conformal Conic
Aerial: Nearmap 02/08/2023

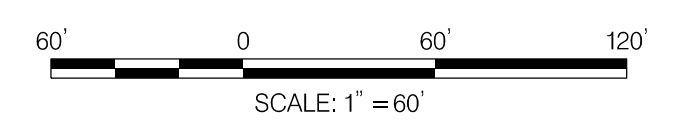

OPERATOR02430 - PLOTTED: 03/19/24
FILE NAME: \\corp.meadhunt.com\shared\folders\entp_4664444\231949.01\TECH\CAD\drawings\UMD_drawings\UMD_Segment_3_RollPlan.dgn



UMD Segment 3: Parallel Bike Only Path From Rossborough Ln./Regents Dr. to South Gate



Appendix B: Traffic Count – Summary and Raw data

MEAD & HUNT

7055 Samuel Morse Dr. Ste. 100
Columbia, Maryland 21046
443-741-3500

Weather:
Counted By:
Town:
Country

File Name : mowatt In at campus dr
Site Code : 00000000
Start Date : 9/19/2023
Page No : 1

Groups Printed- VEHS&PEDS

Start Time	MOWATT LA From North					CAMPUS DR From East					MOWATT LA From South					CAMPUS DR From West					Int. Total
	Left	Thru	Right	Peds	App. Total	Left	Thru	Right	Peds	App. Total	Left	Thru	Right	Peds	App. Total	Left	Thru	Right	Peds	App. Total	
08:00 AM	13	8	3	17	41	3	11	10	11	35	37	17	2	5	61	45	16	61	4	126	263
08:15 AM	2	10	1	15	28	0	8	12	10	30	39	13	0	17	69	51	19	46	9	125	252
08:30 AM	3	13	6	12	34	1	9	10	6	26	41	5	1	17	64	58	7	67	8	140	264
08:45 AM	6	12	3	15	36	2	8	13	14	37	48	22	1	14	85	76	10	82	11	179	337
Total	24	43	13	59	139	6	36	45	41	128	165	57	4	53	279	230	52	256	32	570	1116
09:00 AM	10	11	7	32	60	1	14	9	19	43	72	0	1	22	95	115	12	58	17	202	400
09:15 AM	8	24	8	22	62	1	11	10	60	82	69	1	0	35	105	84	14	57	22	177	426
09:30 AM	5	15	11	6	37	3	20	16	46	85	46	6	3	23	78	80	14	39	13	146	346
09:45 AM	7	11	8	12	38	2	16	11	27	56	33	10	0	24	67	61	15	50	21	147	308
Total	30	61	34	72	197	7	61	46	152	266	220	17	4	104	345	340	55	204	73	672	1480
*** BREAK ***																					
03:30 PM	5	25	14	18	62	8	18	17	22	65	72	18	1	19	110	26	8	47	38	119	356
03:45 PM	7	27	8	9	51	9	7	12	22	50	71	23	1	21	116	28	4	61	24	117	334
Total	12	52	22	27	113	17	25	29	44	115	143	41	2	40	226	54	12	108	62	236	690
04:00 PM	9	15	11	11	46	1	14	7	15	37	78	15	1	19	113	22	17	49	14	102	298
04:15 PM	6	23	11	13	53	2	22	8	12	44	75	16	1	3	95	21	10	34	15	80	272
04:30 PM	1	21	11	13	46	2	19	7	26	54	71	15	2	15	103	27	12	62	6	107	310
04:45 PM	4	27	21	27	79	3	14	9	57	83	66	22	1	19	108	27	14	60	23	124	394
Total	20	86	54	64	224	8	69	31	110	218	290	68	5	56	419	97	53	205	58	413	1274
05:00 PM	4	32	18	21	75	5	20	14	34	73	75	32	2	14	123	30	15	56	26	127	398
05:15 PM	6	32	10	15	63	9	7	12	15	43	81	26	4	5	116	28	8	46	16	98	320
Grand Total	96	306	151	258	811	52	218	177	396	843	974	241	21	272	1508	779	195	875	267	2116	5278
Apprch %	11.8	37.7	18.6	31.8		6.2	25.9	21	47		64.6	16	1.4	18		36.8	9.2	41.4	12.6		
Total %	1.8	5.8	2.9	4.9	15.4	1	4.1	3.4	7.5	16	18.5	4.6	0.4	5.2	28.6	14.8	3.7	16.6	5.1	40.1	

MEAD & HUNT

7055 Samuel Morse Dr. Ste. 100
Columbia, Maryland 21046

443-741-3500

File Name : mowatt In at campus dr

Site Code : 00000000

Start Date : 9/19/2023

Page No : 2

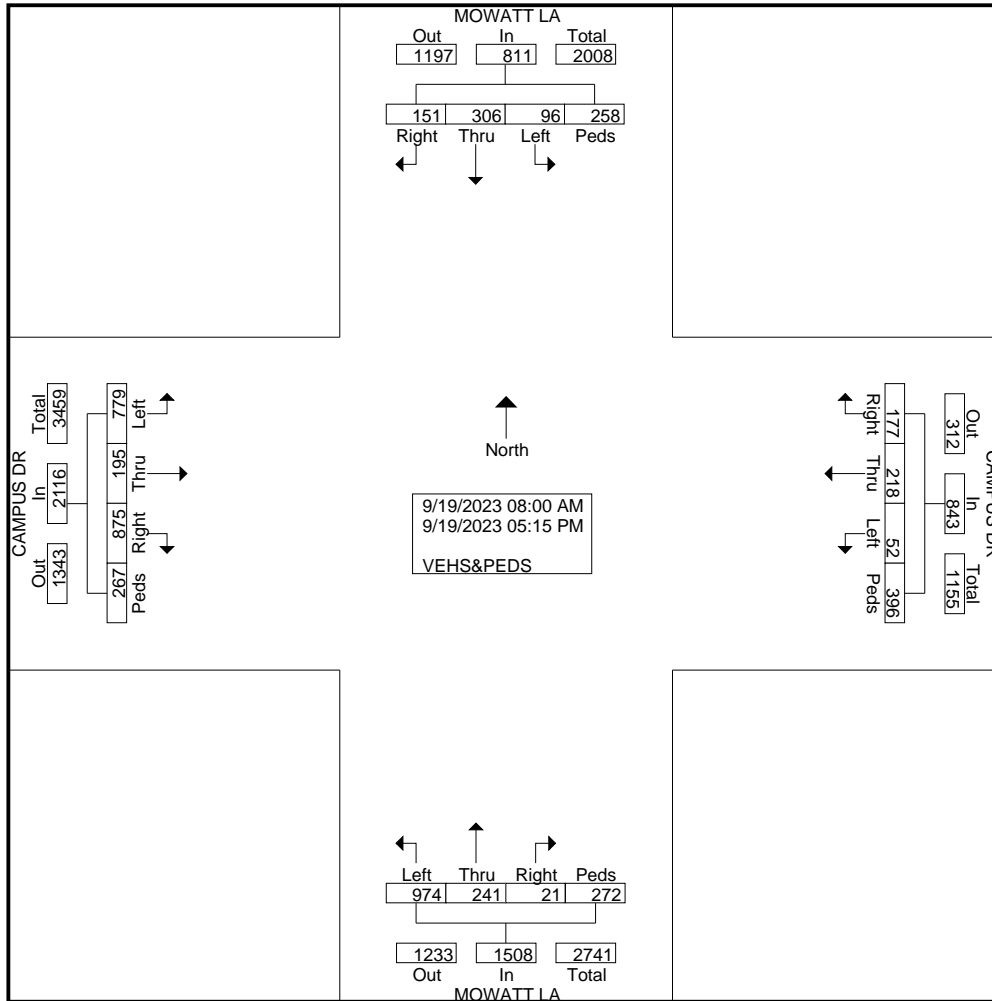

MEAD & HUNT

7055 Samuel Morse Dr. Ste. 100
Columbia, Maryland 21046
443-741-3500

File Name : mowatt In at campus dr
Site Code : 00000000
Start Date : 9/19/2023
Page No : 3

Start Time	MOWATT LA From North					CAMPUS DR From East					MOWATT LA From South					CAMPUS DR From West					Int. Total
	Left	Thru	Right	Peds	App. Total	Left	Thru	Right	Peds	App. Total	Left	Thru	Right	Peds	App. Total	Left	Thru	Right	Peds	App. Total	
Peak Hour Analysis From 08:00 AM to 12:45 PM - Peak 1 of 1																					
Peak Hour for Entire Intersection Begins at 08:45 AM																					
08:45 AM	6	12	3	15	36	2	8	13	14	37	48	22	1	14	85	76	10	82	11	179	337
09:00 AM	10	11	7	32	60	1	14	9	19	43	72	0	1	22	95	115	12	58	17	202	400
09:15 AM	8	24	8	22	62	1	11	10	60	82	69	1	0	35	105	84	14	57	22	177	426
09:30 AM	5	15	11	6	37	3	20	16	46	85	46	6	3	23	78	80	14	39	13	146	346
Total Volume	29	62	29	75	195	7	53	48	139	247	235	29	5	94	363	355	50	236	63	704	1509
% App. Total	14.9	31.8	14.9	38.5		2.8	21.5	19.4	56.3		64.7	8	1.4	25.9		50.4	7.1	33.5	8.9		
PHF	.725	.646	.659	.586	.786	.583	.663	.750	.579	.726	.816	.330	.417	.671	.864	.772	.893	.720	.716	.871	.886

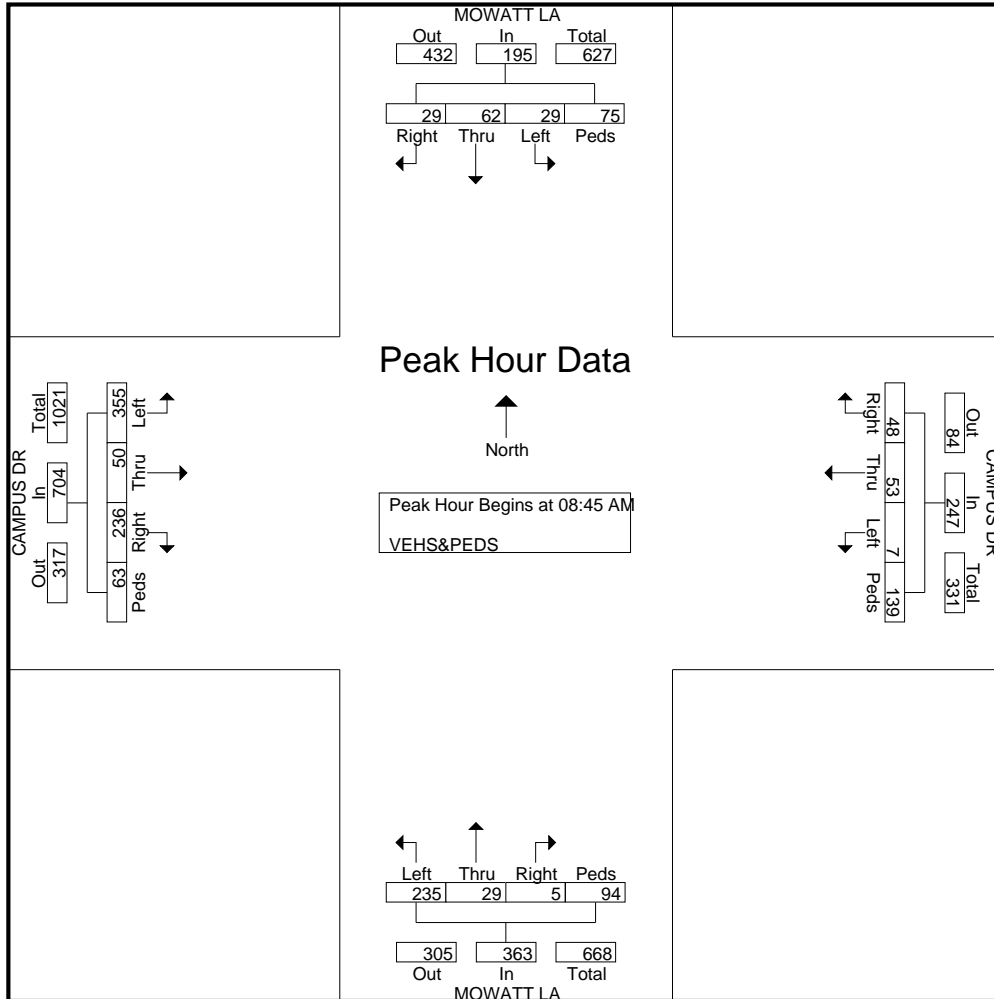

MEAD & HUNT

7055 Samuel Morse Dr. Ste. 100
Columbia, Maryland 21046
443-741-3500

File Name : mowatt In at campus dr
Site Code : 00000000
Start Date : 9/19/2023
Page No : 4

Start Time	MOWATT LA From North					CAMPUS DR From East					MOWATT LA From South					CAMPUS DR From West					Int. Total
	Left	Thru	Right	Peds	App. Total	Left	Thru	Right	Peds	App. Total	Left	Thru	Right	Peds	App. Total	Left	Thru	Right	Peds	App. Total	
Peak Hour Analysis From 01:00 PM to 05:15 PM - Peak 1 of 1																					
Peak Hour for Entire Intersection Begins at 04:30 PM																					
04:30 PM	1	21	11	13	46	2	19	7	26	54	71	15	2	15	103	27	12	62	6	107	310
04:45 PM	4	27	21	27	79	3	14	9	57	83	66	22	1	19	108	27	14	60	23	124	394
05:00 PM	4	32	18	21	75	5	20	14	34	73	75	32	2	14	123	30	15	56	26	127	398
05:15 PM	6	32	10	15	63	9	7	12	15	43	81	26	4	5	116	28	8	46	16	98	320
Total Volume	15	112	60	76	263	19	60	42	132	253	293	95	9	53	450	112	49	224	71	456	1422
% App. Total	5.7	42.6	22.8	28.9		7.5	23.7	16.6	52.2		65.1	21.1	2	11.8		24.6	10.7	49.1	15.6		
PHF	.625	.875	.714	.704	.832	.528	.750	.750	.579	.762	.904	.742	.563	.697	.915	.933	.817	.903	.683	.898	.893

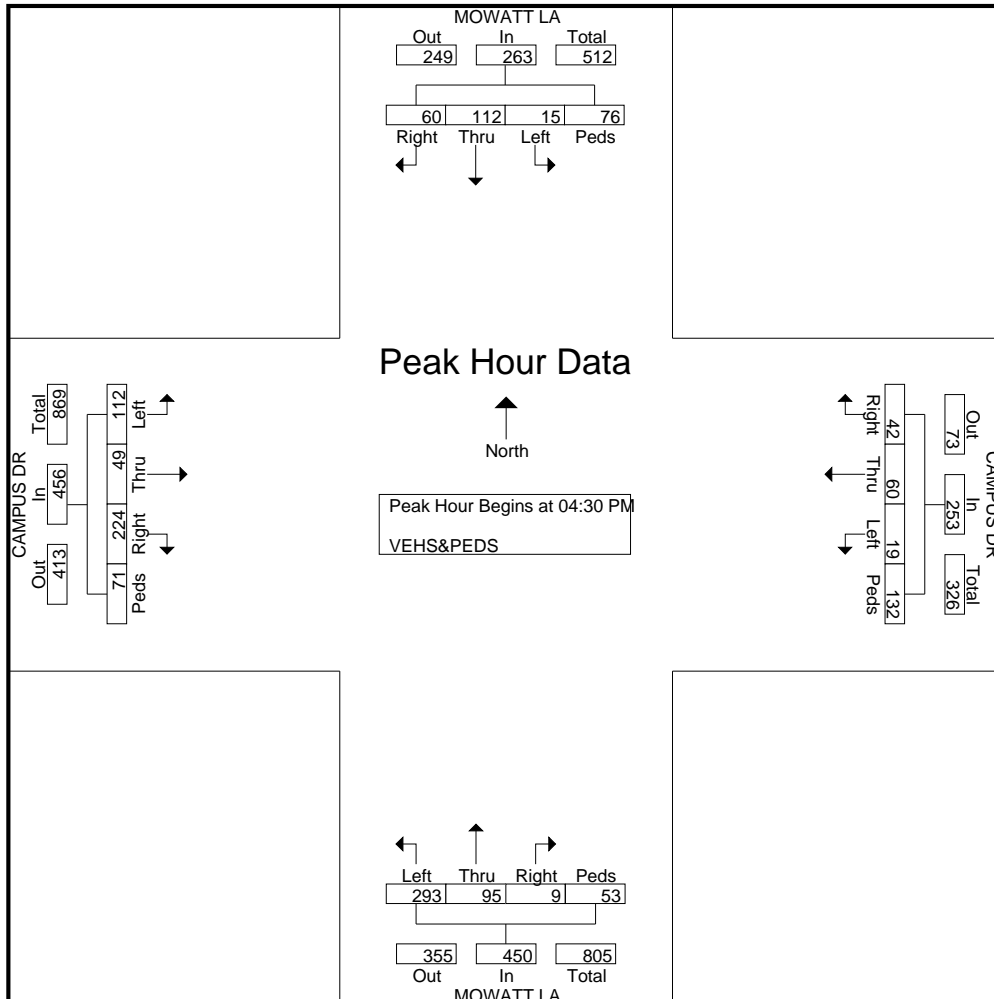

MEAD & HUNT

7055 Samuel Morse Dr. Ste. 100
Columbia, Maryland 21046

443-741-3500

Weather:
Counted By:
Town:
Country

File Name : mowatt In at campus dr
Site Code : 00000000
Start Date : 9/19/2023
Page No : 1

Groups Printed- BICYCLES

Start Time	MOWATT LA From North					CAMPUS DR From East					MOWATT LA From South					CAMPUS DR From West					Int. Total
	Left	Thru	Right	Peds	App. Total	Left	Thru	Right	Peds	App. Total	Left	Thru	Right	Peds	App. Total	Left	Thru	Right	Peds	App. Total	
08:00 AM	0	0	1	0	1	0	0	0	1	1	0	1	0	0	1	0	2	0	1	3	6
08:15 AM	1	0	0	0	1	0	0	1	1	2	0	2	0	0	2	1	1	0	2	4	9
08:30 AM	1	0	0	0	1	0	0	0	0	0	0	0	0	0	0	0	0	0	0	0	1
08:45 AM	1	2	0	0	3	0	0	1	0	1	0	0	1	0	1	2	1	0	1	4	9
Total	3	2	1	0	6	0	0	2	2	4	0	3	1	0	4	3	4	0	4	11	25
09:00 AM	0	0	0	0	0	0	0	1	0	1	0	2	2	0	4	1	4	0	3	8	13
09:15 AM	1	1	0	1	3	0	0	2	1	3	0	3	0	0	3	1	3	2	5	11	20
09:30 AM	1	1	1	0	3	0	0	0	1	1	0	1	0	0	1	1	2	0	2	5	10
09:45 AM	0	0	0	0	0	0	0	0	0	0	0	0	0	0	0	1	4	0	0	5	5
Total	2	2	1	1	6	0	0	3	2	5	0	6	2	0	8	4	13	2	10	29	48
*** BREAK ***																					
03:30 PM	0	2	0	1	3	0	1	0	2	3	0	1	0	1	2	2	3	1	1	7	15
03:45 PM	0	0	1	0	1	0	2	0	2	4	0	0	0	0	0	2	1	1	2	6	11
Total	0	2	1	1	4	0	3	0	4	7	0	1	0	1	2	4	4	2	3	13	26
04:00 PM	0	0	1	0	1	0	1	2	1	4	0	0	0	0	0	0	1	0	0	1	6
04:15 PM	0	0	1	1	2	0	1	0	2	3	2	0	0	0	2	1	1	0	0	2	9
04:30 PM	0	0	1	0	1	0	3	0	0	3	0	0	0	0	0	0	0	0	1	1	5
04:45 PM	0	1	3	0	4	1	0	3	3	7	0	0	2	0	2	0	2	0	1	3	16
Total	0	1	6	1	8	1	5	5	6	17	2	0	2	0	4	1	4	0	2	7	36
05:00 PM	0	0	2	0	2	0	2	0	1	3	0	1	0	0	1	0	0	0	1	1	7
05:15 PM	1	2	2	0	5	0	4	0	1	5	1	0	1	0	2	1	0	0	0	1	13
Grand Total	6	9	13	3	31	1	14	10	16	41	3	11	6	1	21	13	25	4	20	62	155
Apprch %	19.4	29	41.9	9.7		2.4	34.1	24.4	39		14.3	52.4	28.6	4.8		21	40.3	6.5	32.3		
Total %	3.9	5.8	8.4	1.9	20	0.6	9	6.5	10.3	26.5	1.9	7.1	3.9	0.6	13.5	8.4	16.1	2.6	12.9	40	

MEAD & HUNT

7055 Samuel Morse Dr. Ste. 100
Columbia, Maryland 21046

443-741-3500

File Name : mowatt In at campus dr

Site Code : 00000000

Start Date : 9/19/2023

Page No : 2

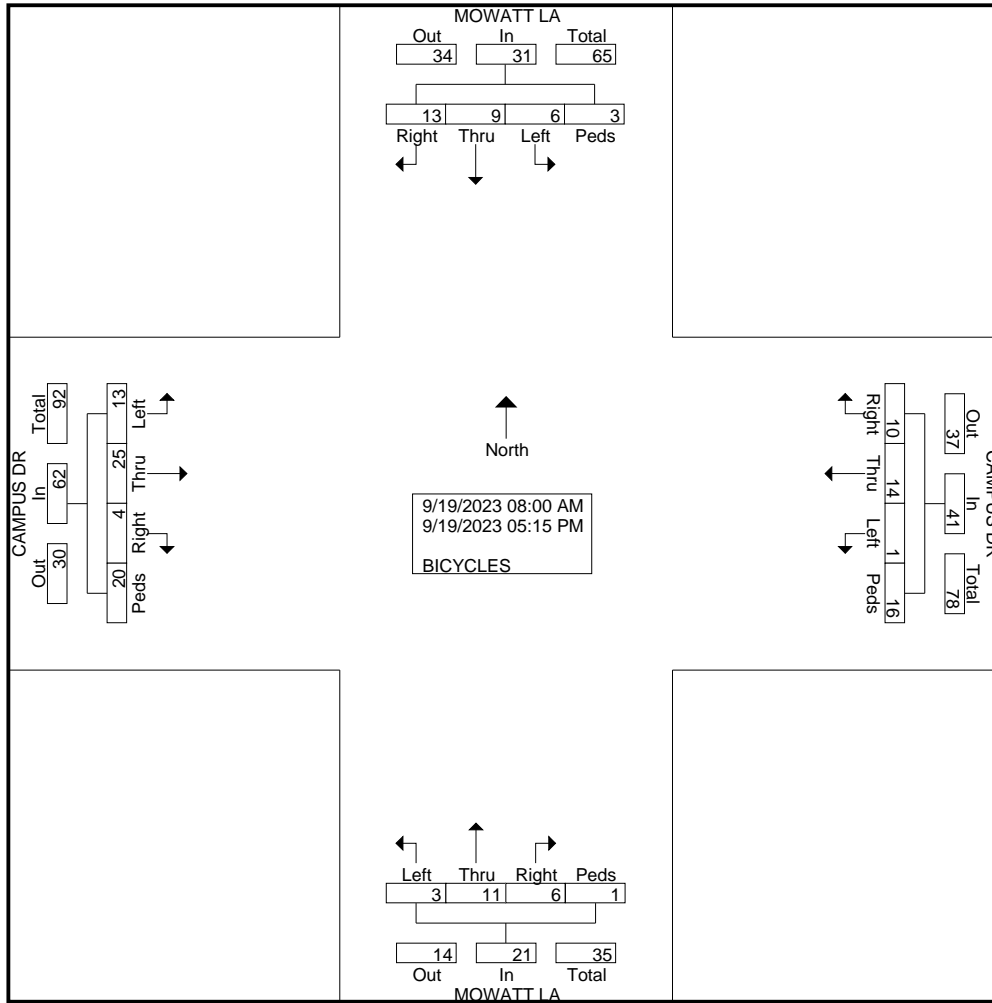

MEAD & HUNT

7055 Samuel Morse Dr. Ste. 100
Columbia, Maryland 21046
443-741-3500

Weather:
Counted By:
Town:
Country

File Name : mowatt In at campus dr
Site Code : 00000000
Start Date : 9/19/2023
Page No : 1

Groups Printed- SCOOTERS

Start Time	MOWATT LA From North					CAMPUS DR From East					MOWATT LA From South					CAMPUS DR From West					Int. Total
	Left	Thru	Right	Peds	App. Total	Left	Thru	Right	Peds	App. Total	Left	Thru	Right	Peds	App. Total	Left	Thru	Right	Peds	App. Total	
08:00 AM	0	0	0	0	0	0	0	0	0	0	0	1	0	0	1	0	0	1	0	1	2
08:15 AM	0	2	0	0	2	0	0	1	0	1	0	0	0	0	0	0	0	1	0	1	4
08:30 AM	0	0	0	0	0	0	0	1	0	1	0	1	1	0	2	1	0	0	0	1	4
08:45 AM	0	0	2	0	2	0	0	2	0	2	0	1	2	0	3	3	2	0	0	5	12
Total	0	2	2	0	4	0	0	4	0	4	0	3	3	0	6	4	2	2	0	8	22
09:00 AM	1	1	0	0	2	0	0	0	0	0	0	1	1	0	2	0	0	0	0	0	4
09:15 AM	3	6	0	0	9	1	0	2	0	3	0	2	2	0	4	0	3	1	0	4	20
09:30 AM	0	2	1	0	3	0	0	0	0	0	0	1	1	0	2	0	0	2	0	2	7
09:45 AM	1	1	0	0	2	0	0	2	0	2	0	0	2	0	2	2	1	0	0	3	9
Total	5	10	1	0	16	1	0	4	0	5	0	4	6	0	10	2	4	3	0	9	40
*** BREAK ***																					
03:30 PM	0	0	0	0	0	1	3	0	0	4	0	0	0	0	0	3	0	0	0	3	7
03:45 PM	1	1	1	0	3	0	2	6	0	8	1	1	0	0	2	1	0	0	0	1	14
Total	1	1	1	0	3	1	5	6	0	12	1	1	0	0	2	4	0	0	0	4	21
04:00 PM	2	7	1	0	10	0	1	1	0	2	1	0	0	0	1	0	1	0	0	1	14
04:15 PM	0	2	1	0	3	0	0	0	0	0	0	3	0	0	3	0	0	0	0	0	6
04:30 PM	0	1	2	0	3	1	2	3	0	6	1	2	0	0	3	0	0	0	0	0	12
04:45 PM	3	0	0	0	3	0	0	1	0	1	1	0	1	0	2	0	3	2	0	5	11
Total	5	10	4	0	19	1	3	5	0	9	3	5	1	0	9	0	4	2	0	6	43
05:00 PM	0	2	0	0	2	0	0	0	0	0	0	0	0	0	0	1	0	0	0	1	3
05:15 PM	0	3	0	0	3	0	1	0	0	1	0	0	0	0	0	0	0	0	0	0	4
Grand Total	11	28	8	0	47	3	9	19	0	31	4	13	10	0	27	11	10	7	0	28	133
Apprch %	23.4	59.6	17	0		9.7	29	61.3	0		14.8	48.1	37	0		39.3	35.7	25	0		
Total %	8.3	21.1	6	0	35.3	2.3	6.8	14.3	0	23.3	3	9.8	7.5	0	20.3	8.3	7.5	5.3	0	21.1	

MEAD & HUNT

7055 Samuel Morse Dr. Ste. 100
Columbia, Maryland 21046

443-741-3500

File Name : mowatt In at campus dr

Site Code : 00000000

Start Date : 9/19/2023

Page No : 2

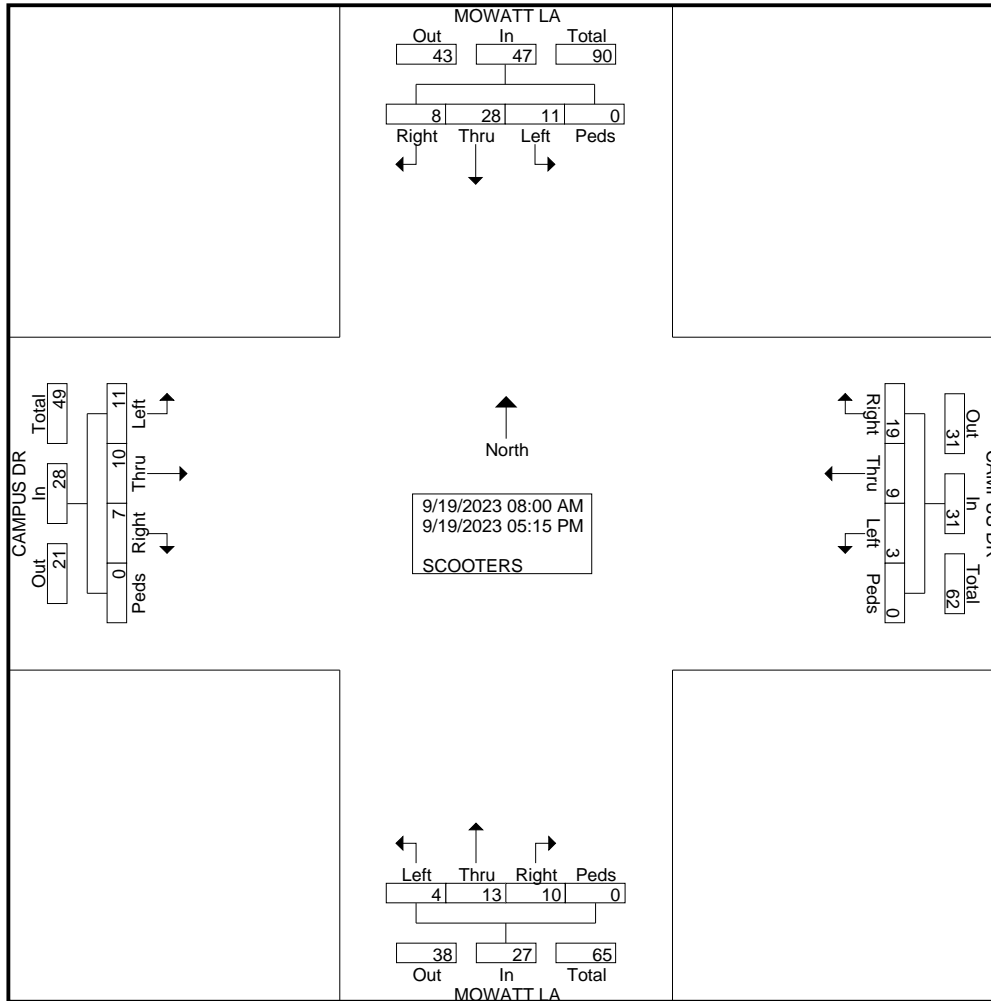

MEAD & HUNT

7055 Samuel Morse Dr. Ste. 100
Columbia, Maryland 21046
443-741-3500

Weather:
Counted By:
Town:
Country

File Name : mowatt In at campus dr
Site Code : 00000000
Start Date : 9/19/2023
Page No : 1

Groups Printed- BUSES

Start Time	MOWATT LA From North					CAMPUS DR From East					MOWATT LA From South					CAMPUS DR From West					Int. Total
	Left	Thru	Right	Peds	App. Total	Left	Thru	Right	Peds	App. Total	Left	Thru	Right	Peds	App. Total	Left	Thru	Right	Peds	App. Total	
08:00 AM	0	0	0	0	0	0	2	0	0	2	0	0	0	0	0	0	0	0	1	1	3
*** BREAK ***																					
08:30 AM	0	0	0	0	0	0	0	0	0	0	0	0	0	0	0	0	0	1	0	1	1
08:45 AM	0	0	0	0	0	0	0	0	0	0	1	0	0	0	1	0	0	0	0	0	1
Total	0	0	0	0	0	0	2	0	0	2	1	0	0	0	1	0	0	1	1	2	5
09:00 AM	2	0	0	0	2	0	1	1	0	2	1	0	0	0	1	0	0	0	0	0	5
09:15 AM	0	0	0	0	0	0	1	0	0	1	0	0	0	0	0	1	0	0	0	1	2
09:30 AM	0	0	0	0	0	0	1	1	0	2	0	0	0	0	0	0	0	0	0	0	2
*** BREAK ***																					
Total	2	0	0	0	2	0	3	2	0	5	1	0	0	0	1	1	0	0	0	1	9
*** BREAK ***																					
03:30 PM	0	0	0	0	0	0	0	2	0	2	0	0	0	0	0	0	0	0	0	0	2
03:45 PM	0	0	0	0	0	0	1	0	0	1	1	0	0	0	1	1	0	0	0	1	3
Total	0	0	0	0	0	0	1	2	0	3	1	0	0	0	1	1	0	0	0	1	5
04:00 PM	0	0	0	0	0	0	0	0	0	0	0	0	0	0	0	1	0	0	0	1	1
04:15 PM	0	1	0	0	1	0	1	0	0	1	0	0	0	0	0	1	0	0	0	1	3
04:30 PM	0	0	0	0	0	0	1	0	0	1	0	0	0	0	0	0	0	0	1	1	2
*** BREAK ***																					
Total	0	1	0	0	1	0	2	0	0	2	0	0	0	0	0	2	0	0	1	3	6
05:00 PM	0	0	0	0	0	0	0	0	0	0	0	0	0	0	0	0	0	0	1	1	1
05:15 PM	0	0	0	0	0	0	2	1	0	3	0	2	0	0	2	1	0	0	0	1	6
Grand Total	2	1	0	0	3	0	10	5	0	15	3	2	0	0	5	5	0	1	3	9	32
Apprch %	66.7	33.3	0	0		0	66.7	33.3	0		60	40	0	0		55.6	0	11.1	33.3		
Total %	6.2	3.1	0	0	9.4	0	31.2	15.6	0	46.9	9.4	6.2	0	0	15.6	15.6	0	3.1	9.4	28.1	

MEAD & HUNT

7055 Samuel Morse Dr. Ste. 100
Columbia, Maryland 21046

443-741-3500

File Name : mowatt In at campus dr

Site Code : 00000000

Start Date : 9/19/2023

Page No : 2

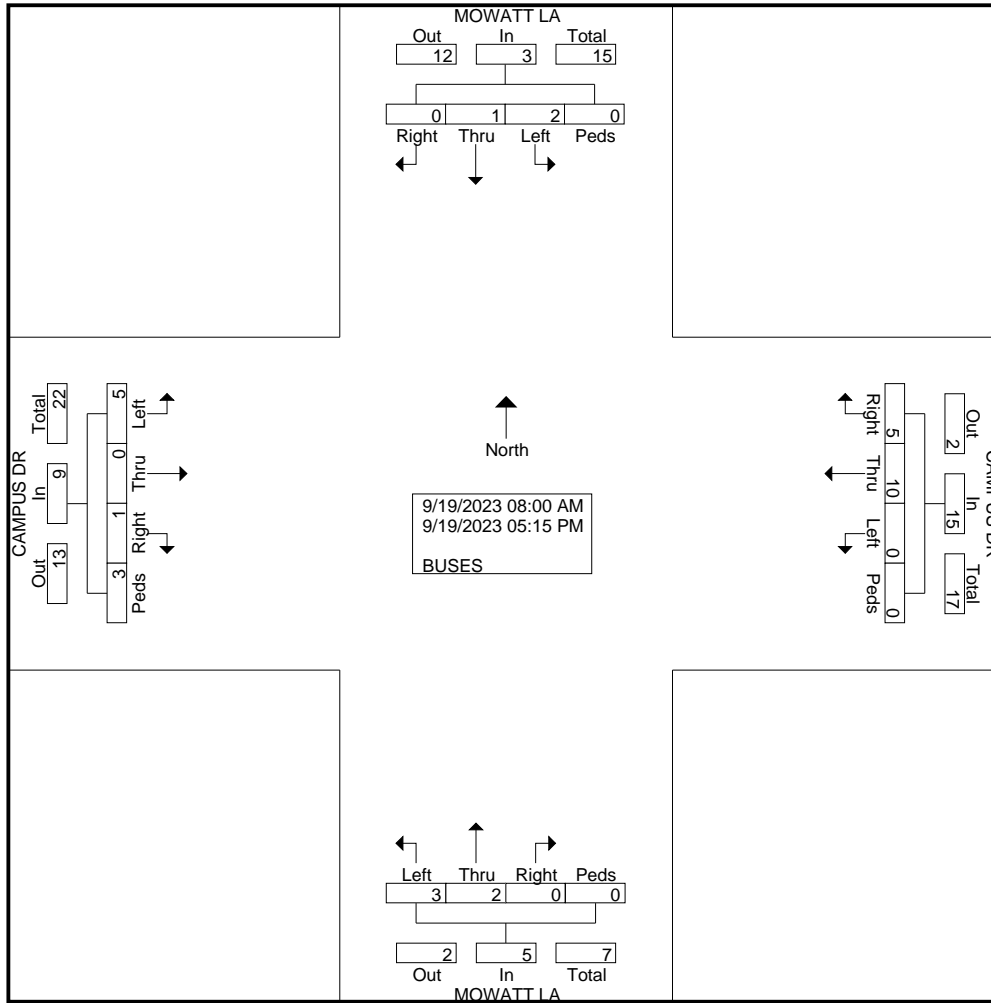

MEAD & HUNT

7055 Samuel Morse Dr. Ste. 100
Columbia, Maryland 21046

443-741-3500

File Name : mowatt In at campus dr

Site Code : 00000000

Start Date : 9/19/2023

Page No : 3

Start Time	MOWATT LA From North					CAMPUS DR From East					MOWATT LA From South					CAMPUS DR From West					Int. Total
	Left	Thru	Right	Peds	App. Total	Left	Thru	Right	Peds	App. Total	Left	Thru	Right	Peds	App. Total	Left	Thru	Right	Peds	App. Total	
Peak Hour Analysis From 08:00 AM to 12:45 PM - Peak 1 of 1																					
Peak Hour for Entire Intersection Begins at 08:45 AM																					
08:45 AM	0	0	0	0	0	0	0	0	0	0	1	0	0	0	1	0	0	0	0	0	1
09:00 AM	2	0	0	0	2	0	1	1	0	2	1	0	0	0	1	0	0	0	0	0	5
09:15 AM	0	0	0	0	0	0	1	0	0	1	0	0	0	0	0	1	0	0	0	0	2
09:30 AM	0	0	0	0	0	0	1	1	0	2	0	0	0	0	0	0	0	0	0	0	2
Total Volume	2	0	0	0	2	0	3	2	0	5	2	0	0	0	2	1	0	0	0	1	10
% App. Total	100	0	0	0		0	60	40	0		100	0	0	0		100	0	0	0		
PHF	.250	.000	.000	.000	.250	.000	.750	.500	.000	.625	.500	.000	.000	.000	.500	.250	.000	.000	.000	.250	.500

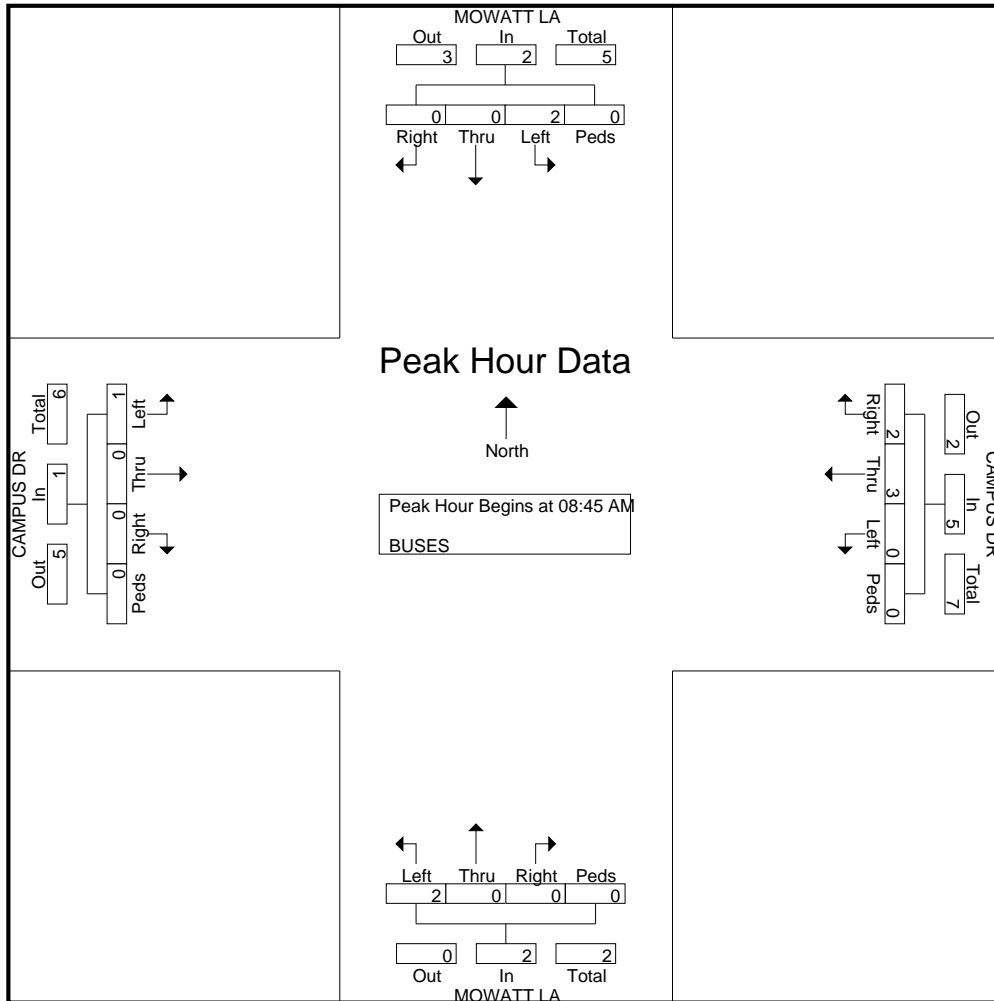

MEAD & HUNT

7055 Samuel Morse Dr. Ste. 100
Columbia, Maryland 21046
443-741-3500

File Name : mowatt In at campus dr
Site Code : 00000000
Start Date : 9/19/2023
Page No : 4

Start Time	MOWATT LA From North					CAMPUS DR From East					MOWATT LA From South					CAMPUS DR From West					Int. Total	
	Left	Thru	Right	Peds	App. Total	Left	Thru	Right	Peds	App. Total	Left	Thru	Right	Peds	App. Total	Left	Thru	Right	Peds	App. Total		
Peak Hour Analysis From 01:00 PM to 05:15 PM - Peak 1 of 1																						
Peak Hour for Entire Intersection Begins at 03:30 PM																						
03:30 PM	0	0	0	0	0	0	0	2	0	2	0	0	0	0	0	0	0	0	0	0	0	2
03:45 PM	0	0	0	0	0	0	1	0	0	1	1	0	0	0	1	1	0	0	0	0	1	3
04:00 PM	0	0	0	0	0	0	0	0	0	0	0	0	0	0	0	0	1	0	0	0	1	1
04:15 PM	0	1	0	0	1	0	1	0	0	1	0	0	0	0	0	1	0	0	0	0	1	3
Total Volume	0	1	0	0	1	0	2	2	0	4	1	0	0	0	1	3	0	0	0	0	3	9
% App. Total	0	100	0	0		0	50	50	0		100	0	0	0		100	0	0	0			
PHF	.000	.250	.000	.000	.250	.000	.500	.250	.000	.500	.250	.000	.000	.000	.250	.750	.000	.000	.000	.750		.750

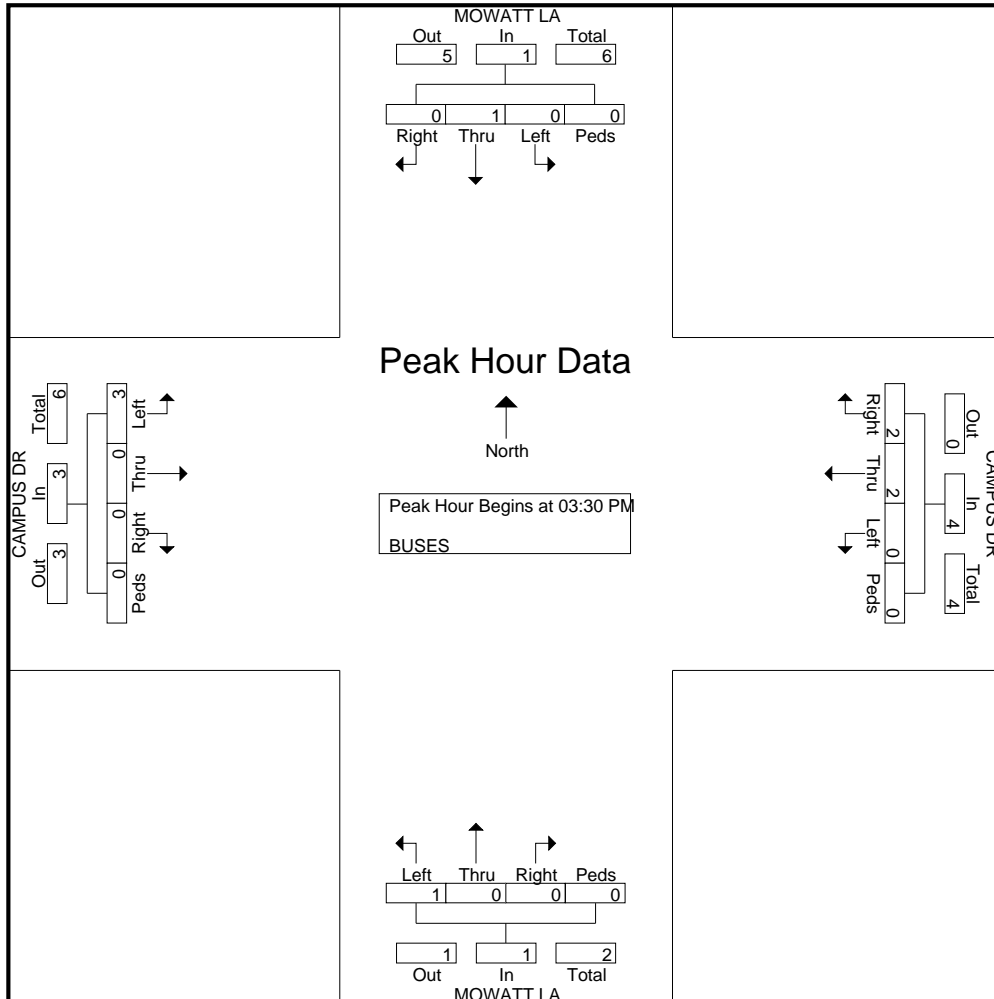

MEAD & HUNT

7055 Samuel Morse Dr. Ste. 100
Columbia, Maryland 21046
443-741-3500

Weather:
Counted By:
Town:
Country

File Name : mowatt In at campus dr
Site Code : 00000000
Start Date : 9/19/2023
Page No : 1

Groups Printed- U TURNS

Start Time	MOWATT LA From North					CAMPUS DR From East					MOWATT LA From South					CAMPUS DR From West					Int. Total
	Left	Thru	Right	Peds	App. Total	Left	Thru	Right	Peds	App. Total	Left	Thru	Right	Peds	App. Total	Left	Thru	Right	Peds	App. Total	
08:00 AM	0	0	0	0	0	0	0	0	0	0	0	0	0	0	0	1	0	0	0	0	1
*** BREAK ***																					
Total	0	0	0	0	0	0	0	0	0	0	0	0	0	0	0	1	0	0	0	0	1
09:00 AM	0	0	0	0	0	0	0	0	0	0	0	0	0	0	0	1	0	0	0	0	1
09:15 AM	0	0	0	0	0	0	0	0	0	0	0	0	0	0	0	7	0	0	0	0	7
*** BREAK ***																					
Total	0	0	0	0	0	0	0	0	0	0	0	0	0	0	0	8	0	0	0	0	8
*** BREAK ***																					
04:30 PM	0	0	0	0	0	0	0	0	0	0	0	0	0	0	0	1	0	0	0	0	1
*** BREAK ***																					
Total	0	0	0	0	0	0	0	0	0	0	0	0	0	0	0	1	0	0	0	0	1
05:00 PM	0	0	0	0	0	0	0	0	0	0	0	0	0	0	0	1	0	0	0	0	1
*** BREAK ***																					
Grand Total	0	0	0	0	0	0	0	0	0	0	0	0	0	0	0	11	0	0	0	0	11
Apprch %	0	0	0	0	0	0	0	0	0	0	0	0	0	0	0	100	0	0	0	0	
Total %	0	0	0	0	0	0	0	0	0	0	0	0	0	0	0	100	0	0	0	0	100

MEAD & HUNT

7055 Samuel Morse Dr. Ste. 100
Columbia, Maryland 21046

443-741-3500

File Name : mowatt In at campus dr

Site Code : 00000000

Start Date : 9/19/2023

Page No : 2

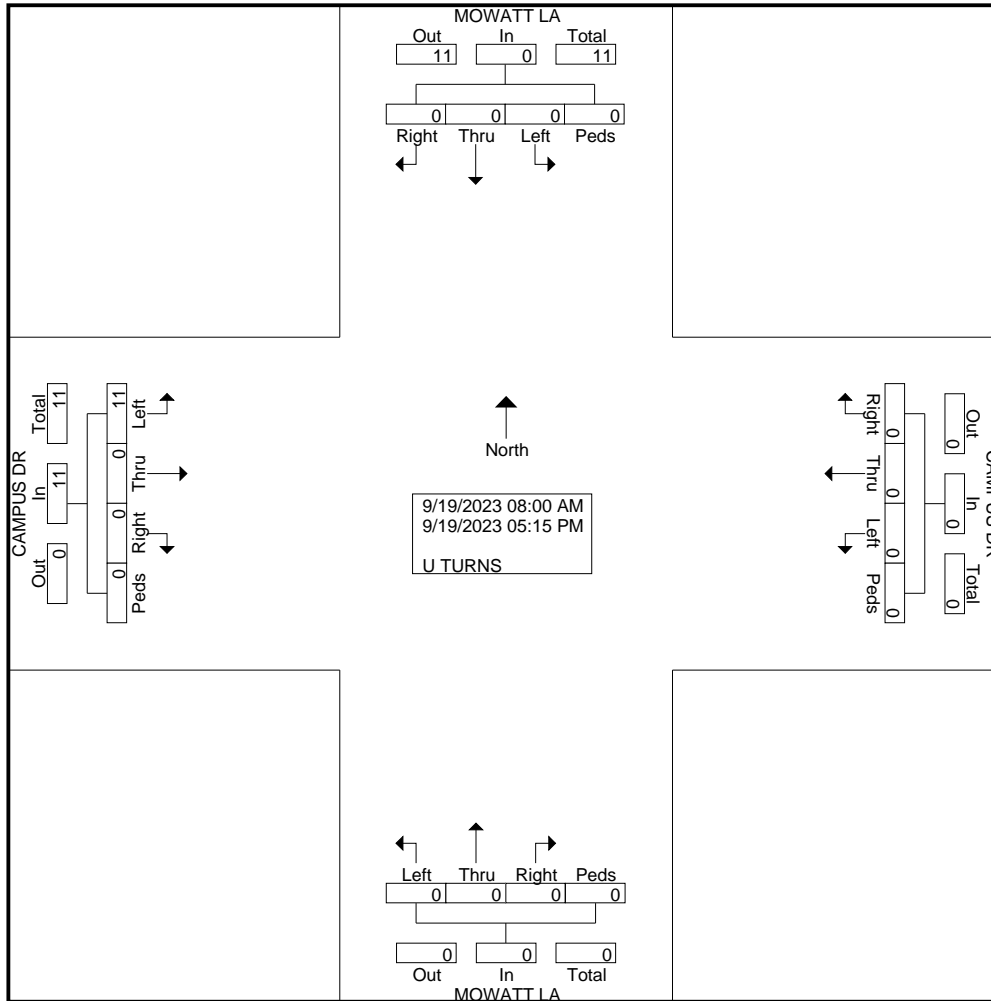

MEAD & HUNT

7055 Samuel Morse Dr. Ste. 100
Columbia, Maryland 21046
443-741-3500

Weather:
Counted By:
Town:
Country

File Name : paint branch dr at campus dr
Site Code : 00000000
Start Date : 9/19/2023
Page No : 1

Groups Printed- VEHS&PEDS

Start Time	PAINT BRANCH DR From North					COLLEGE AVE From East					From South					COLLEGE AVE From West					Int. Total
	Left	Thru	Right	Peds	App. Total	Left	Thru	Right	Peds	App. Total	Left	Thru	Right	Peds	App. Total	Left	Thru	Right	Peds	App. Total	
08:00 AM	23	0	4	0	27	0	78	43	0	121	0	0	0	0	0	2	16	0	11	29	177
08:15 AM	25	0	5	0	30	0	87	39	1	127	0	0	0	0	0	2	11	0	8	21	178
08:30 AM	23	0	6	1	30	0	95	54	0	149	0	0	0	0	0	3	13	0	14	30	209
08:45 AM	28	0	8	2	38	0	92	85	0	177	0	0	0	0	0	2	19	0	35	56	271
Total	99	0	23	3	125	0	352	221	1	574	0	0	0	0	0	9	59	0	68	136	835
09:00 AM	20	0	7	0	27	0	89	81	0	170	0	0	0	0	0	2	17	0	33	52	249
09:15 AM	24	0	9	0	33	0	75	74	0	149	0	0	0	0	0	5	18	0	55	78	260
09:30 AM	27	0	3	0	30	0	60	53	0	113	0	0	0	0	0	3	23	0	40	66	209
09:45 AM	20	0	7	0	27	0	59	29	0	88	0	0	0	0	0	4	19	0	27	50	165
Total	91	0	26	0	117	0	283	237	0	520	0	0	0	0	0	14	77	0	155	246	883
*** BREAK ***																					
03:30 PM	51	0	8	1	60	0	30	17	0	47	0	0	0	0	0	5	44	0	51	100	207
03:45 PM	36	0	6	2	44	0	55	28	0	83	0	0	0	0	0	6	52	0	52	110	237
Total	87	0	14	3	104	0	85	45	0	130	0	0	0	0	0	11	96	0	103	210	444
04:00 PM	41	0	4	3	48	0	53	38	2	93	0	0	0	0	0	3	53	0	55	111	252
04:15 PM	41	0	3	1	45	0	44	38	0	82	0	0	0	0	0	4	63	0	41	108	235
04:30 PM	37	0	3	0	40	0	48	23	0	71	0	0	0	0	0	2	64	0	52	118	229
04:45 PM	33	0	12	0	45	0	43	26	0	69	0	0	0	0	0	3	53	0	64	120	234
Total	152	0	22	4	178	0	188	125	2	315	0	0	0	0	0	12	233	0	212	457	950
05:00 PM	44	0	4	1	49	0	55	22	1	78	0	0	0	0	0	4	77	0	39	120	247
05:15 PM	58	0	15	0	73	0	61	30	0	91	0	0	0	0	0	6	96	0	17	119	283
Grand Total	531	0	104	11	646	0	1024	680	4	1708	0	0	0	0	0	56	638	0	594	1288	3642
Apprch %	82.2	0	16.1	1.7		0	60	39.8	0.2		0	0	0	0		4.3	49.5	0	46.1		
Total %	14.6	0	2.9	0.3	17.7	0	28.1	18.7	0.1	46.9	0	0	0	0	0	1.5	17.5	0	16.3	35.4	

MEAD & HUNT

7055 Samuel Morse Dr. Ste. 100
 Columbia, Maryland 21046
 443-741-3500

File Name : paint branch dr at campus dr
 Site Code : 00000000
 Start Date : 9/19/2023
 Page No : 2

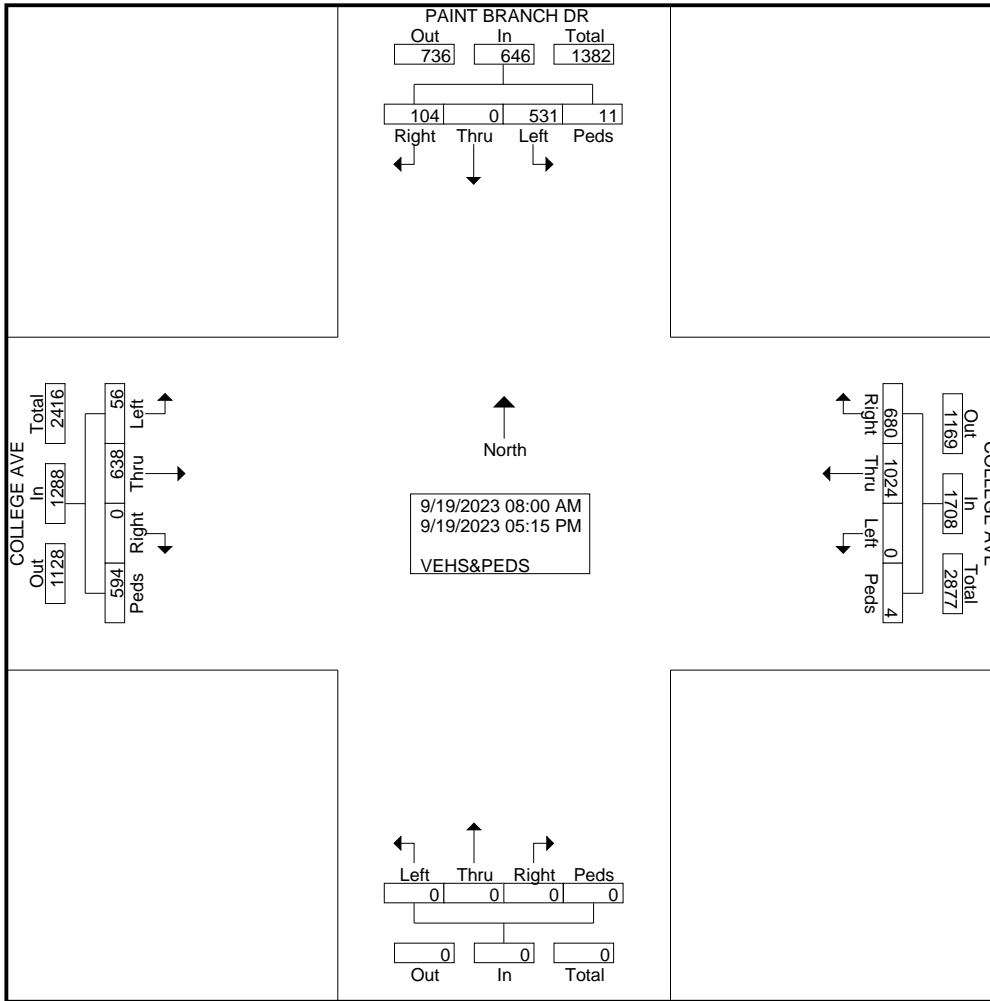

MEAD & HUNT

7055 Samuel Morse Dr. Ste. 100
Columbia, Maryland 21046
443-741-3500

File Name : paint branch dr at campus dr
Site Code : 00000000
Start Date : 9/19/2023
Page No : 3

Start Time	PAINT BRANCH DR From North					COLLEGE AVE From East					From South					COLLEGE AVE From West					Int. Total
	Left	Thru	Right	Peds	App. Total	Left	Thru	Right	Peds	App. Total	Left	Thru	Right	Peds	App. Total	Left	Thru	Right	Peds	App. Total	
Peak Hour Analysis From 08:00 AM to 11:45 AM - Peak 1 of 1																					
Peak Hour for Entire Intersection Begins at 08:30 AM																					
08:30 AM	23	0	6	1	30	0	95	54	0	149	0	0	0	0	0	3	13	0	14	30	209
08:45 AM	28	0	8	2	38	0	92	85	0	177	0	0	0	0	0	2	19	0	35	56	271
09:00 AM	20	0	7	0	27	0	89	81	0	170	0	0	0	0	0	2	17	0	33	52	249
09:15 AM	24	0	9	0	33	0	75	74	0	149	0	0	0	0	0	5	18	0	55	78	260
Total Volume	95	0	30	3	128	0	351	294	0	645	0	0	0	0	0	12	67	0	137	216	989
% App. Total	74.2	0	23.4	2.3		0	54.4	45.6	0		0	0	0	0		5.6	31	0	63.4		
PHF	.848	.000	.833	.375	.842	.000	.924	.865	.000	.911	.000	.000	.000	.000	.000	.600	.882	.000	.623	.692	.912

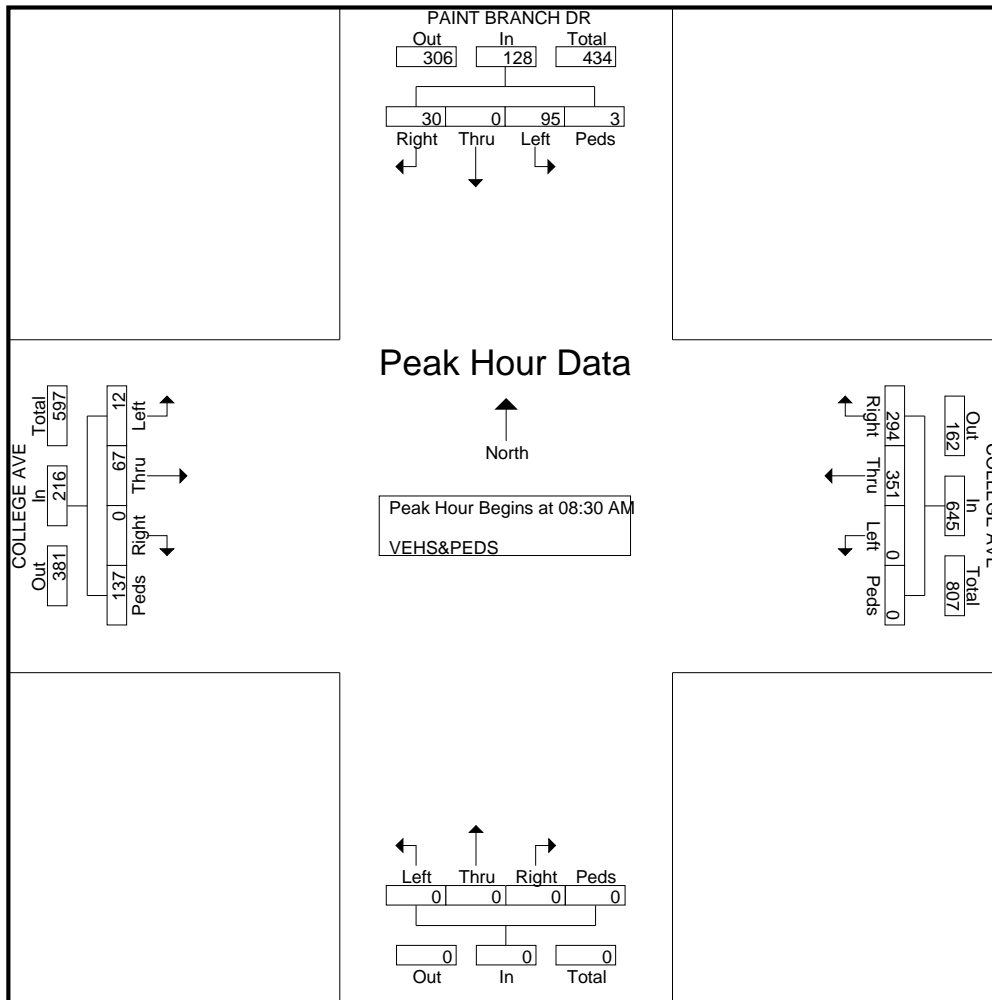

MEAD & HUNT

7055 Samuel Morse Dr. Ste. 100
Columbia, Maryland 21046
443-741-3500

File Name : paint branch dr at campus dr
Site Code : 00000000
Start Date : 9/19/2023
Page No : 4

Start Time	PAINT BRANCH DR From North					COLLEGE AVE From East					From South					COLLEGE AVE From West					Int. Total
	Left	Thru	Right	Peds	App. Total	Left	Thru	Right	Peds	App. Total	Left	Thru	Right	Peds	App. Total	Left	Thru	Right	Peds	App. Total	
Peak Hour Analysis From 12:00 PM to 05:15 PM - Peak 1 of 1																					
Peak Hour for Entire Intersection Begins at 04:30 PM																					
04:30 PM	37	0	3	0	40	0	48	23	0	71	0	0	0	0	0	2	64	0	52	118	229
04:45 PM	33	0	12	0	45	0	43	26	0	69	0	0	0	0	0	3	53	0	64	120	234
05:00 PM	44	0	4	1	49	0	55	22	1	78	0	0	0	0	0	4	77	0	39	120	247
05:15 PM	58	0	15	0	73	0	61	30	0	91	0	0	0	0	0	6	96	0	17	119	283
Total Volume	172	0	34	1	207	0	207	101	1	309	0	0	0	0	0	15	290	0	172	477	993
% App. Total	83.1	0	16.4	0.5		0	67	32.7	0.3		0	0	0	0		3.1	60.8	0	36.1		
PHF	.741	.000	.567	.250	.709	.000	.848	.842	.250	.849	.000	.000	.000	.000	.000	.625	.755	.000	.672	.994	.877

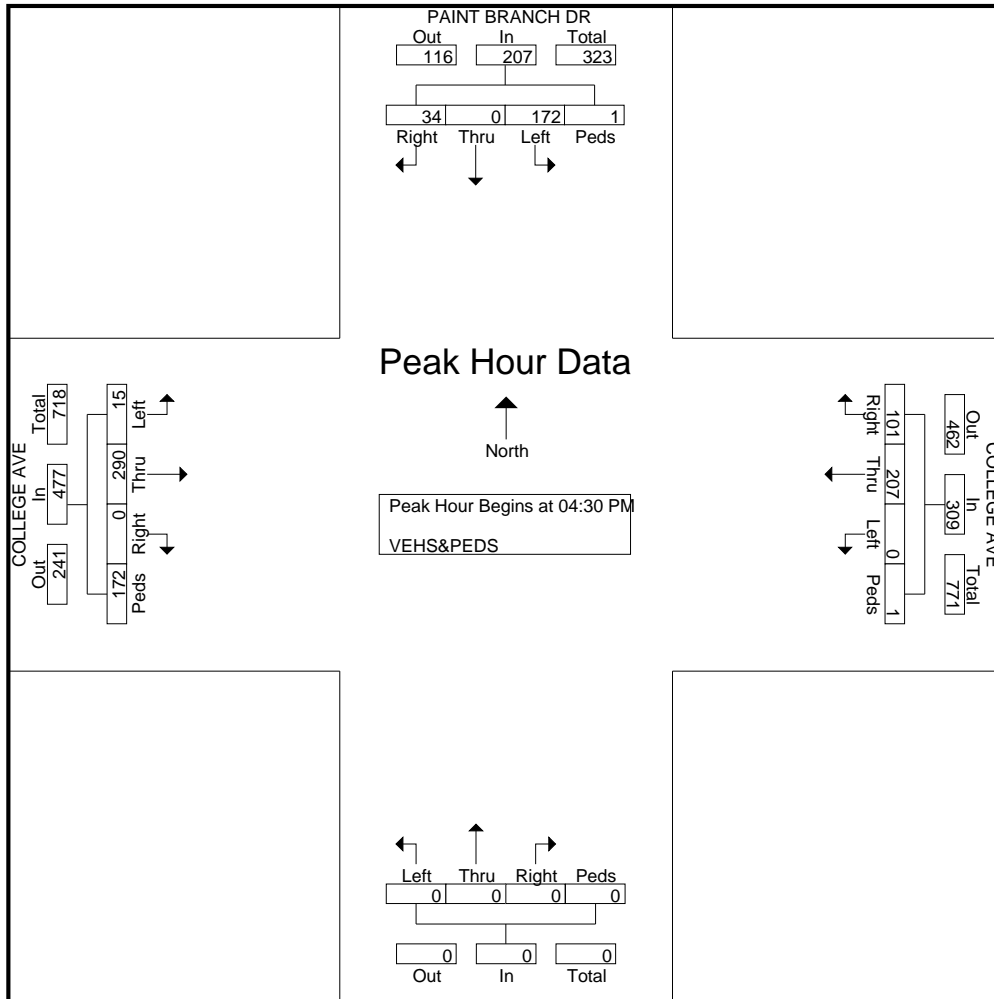

MEAD & HUNT

7055 Samuel Morse Dr. Ste. 100
Columbia, Maryland 21046
443-741-3500

Weather:
Counted By:
Town:
Country

File Name : paint branch dr at campus dr
Site Code : 00000000
Start Date : 9/19/2023
Page No : 1

Groups Printed- BICYCLES

Start Time	PAINT BRANCH DR From North					COLLEGE AVE From East					From South					COLLEGE AVE From West					Int. Total
	Left	Thru	Right	Peds	App. Total	Left	Thru	Right	Peds	App. Total	Left	Thru	Right	Peds	App. Total	Left	Thru	Right	Peds	App. Total	
08:00 AM	0	0	0	0	0	0	0	0	0	0	0	0	0	0	0	0	0	0	1	1	1
08:15 AM	0	0	0	0	0	0	0	0	0	0	0	0	0	0	0	0	0	0	2	2	2
08:30 AM	1	0	0	0	1	0	0	0	0	0	0	0	0	0	0	2	0	0	1	3	4
08:45 AM	0	0	0	0	0	0	0	0	0	0	0	0	0	0	0	2	0	0	4	6	6
Total	1	0	0	0	1	0	0	0	0	0	0	0	0	0	0	4	0	0	8	12	13
09:00 AM	0	0	1	0	1	0	4	0	0	4	0	0	0	0	0	0	0	0	0	0	5
09:15 AM	0	0	12	0	12	0	0	0	0	0	0	0	0	0	0	5	0	0	0	5	17
09:30 AM	1	0	5	0	6	0	1	0	0	1	0	0	0	0	0	8	0	0	0	8	15
09:45 AM	0	0	6	0	6	0	4	1	0	5	0	0	0	0	0	2	0	0	0	2	13
Total	1	0	24	0	25	0	9	1	0	10	0	0	0	0	0	15	0	0	0	15	50
*** BREAK ***																					
03:30 PM	0	0	1	0	1	0	1	1	0	2	0	0	0	0	0	5	0	0	3	8	11
03:45 PM	0	0	3	0	3	0	1	0	0	1	0	0	0	0	0	2	0	0	3	5	9
Total	0	0	4	0	4	0	2	1	0	3	0	0	0	0	0	7	0	0	6	13	20
04:00 PM	0	0	1	0	1	0	0	1	0	1	0	0	0	0	0	1	1	0	1	3	5
04:15 PM	0	0	3	0	3	0	0	1	0	1	0	0	0	0	0	0	0	0	0	0	4
04:30 PM	0	0	2	0	2	0	0	0	0	0	0	0	0	0	0	4	1	0	1	6	8
04:45 PM	0	0	10	0	10	0	0	0	0	0	0	0	0	0	0	8	0	0	3	11	21
Total	0	0	16	0	16	0	0	2	0	2	0	0	0	0	0	13	2	0	5	20	38
05:00 PM	0	0	1	0	1	0	0	0	0	0	0	0	0	0	0	0	0	0	3	3	4
05:15 PM	0	0	0	0	0	0	0	0	0	0	0	0	0	0	0	0	1	0	1	2	2
Grand Total	2	0	45	0	47	0	11	4	0	15	0	0	0	0	0	39	3	0	23	65	127
Apprch %	4.3	0	95.7	0		0	73.3	26.7	0		0	0	0	0		60	4.6	0	35.4		
Total %	1.6	0	35.4	0	37	0	8.7	3.1	0	11.8	0	0	0	0	0	30.7	2.4	0	18.1	51.2	

MEAD & HUNT

7055 Samuel Morse Dr. Ste. 100
Columbia, Maryland 21046

443-741-3500

File Name : paint branch dr at campus dr

Site Code : 00000000

Start Date : 9/19/2023

Page No : 2

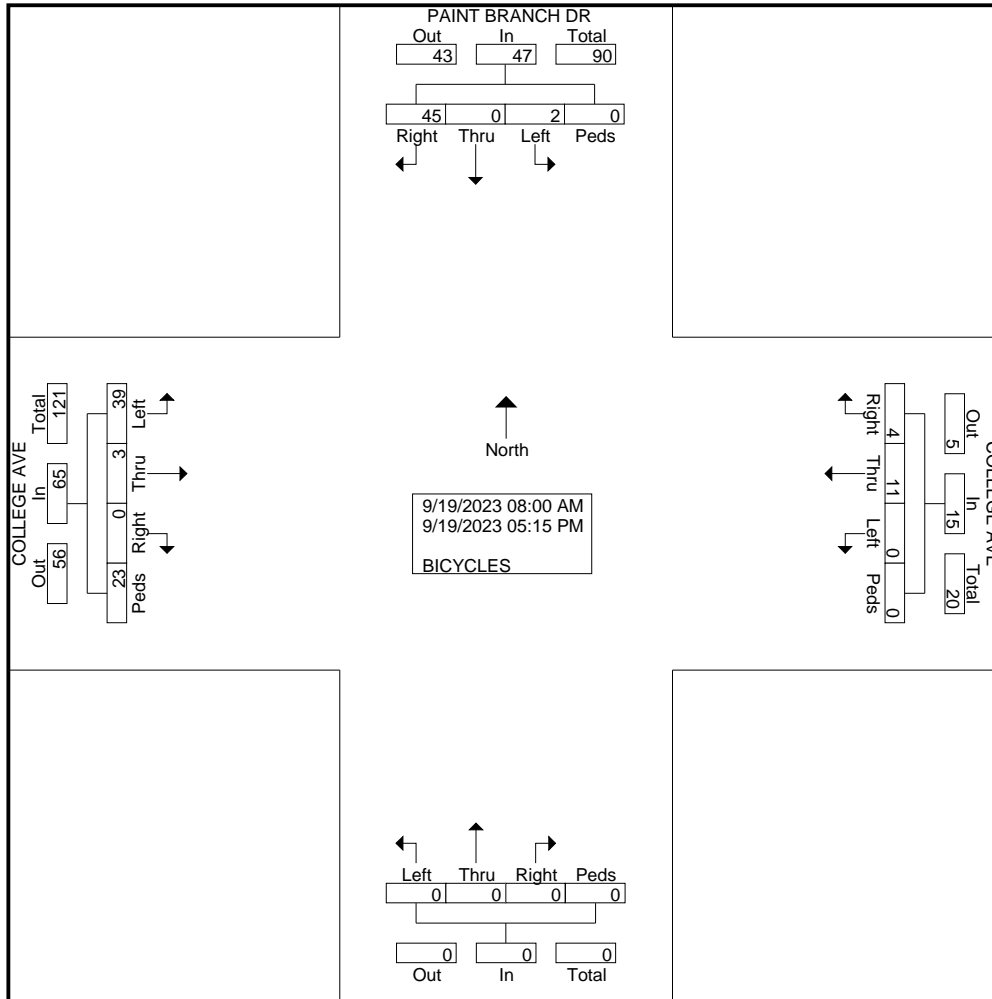

MEAD & HUNT

7055 Samuel Morse Dr. Ste. 100
Columbia, Maryland 21046
443-741-3500

Weather:
Counted By:
Town:
Country

File Name : paint branch dr at campus dr
Site Code : 00000000
Start Date : 9/19/2023
Page No : 1

Groups Printed- SCOOTERS

Start Time	PAINT BRANCH DR From North					COLLEGE AVE From East					From South					COLLEGE AVE From West					Int. Total
	Left	Thru	Right	Peds	App. Total	Left	Thru	Right	Peds	App. Total	Left	Thru	Right	Peds	App. Total	Left	Thru	Right	Peds	App. Total	
*** BREAK ***																					
08:30 AM	0	0	0	0	0	0	0	0	0	0	0	0	0	0	0	2	0	0	0	2	2
08:45 AM	0	0	0	0	0	0	0	0	0	0	0	0	0	0	0	5	0	0	0	5	5
Total	0	0	0	0	0	0	0	0	0	0	0	0	0	0	0	7	0	0	0	7	7
*** BREAK ***																					
03:30 PM	0	0	5	0	5	0	0	0	0	0	0	0	0	0	0	3	0	0	0	3	8
03:45 PM	0	0	1	0	1	0	0	0	0	0	0	0	0	0	0	3	2	0	0	5	6
Total	0	0	6	0	6	0	0	0	0	0	0	0	0	0	0	6	2	0	0	8	14
04:00 PM	1	0	3	0	4	0	0	0	0	0	0	0	0	0	0	6	1	0	0	7	11
04:15 PM	2	0	7	0	9	0	0	0	0	0	0	0	0	0	0	4	0	0	0	4	13
*** BREAK ***																					
04:45 PM	0	0	0	0	0	0	0	0	0	0	0	0	0	0	0	0	1	0	0	1	1
Total	3	0	10	0	13	0	0	0	0	0	0	0	0	0	0	10	2	0	0	12	25
05:00 PM	0	0	0	0	0	0	0	1	0	1	0	0	0	0	0	0	0	0	0	0	1
05:15 PM	0	0	0	0	0	0	0	0	0	0	0	0	0	0	0	0	1	0	0	1	1
Grand Total	3	0	16	0	19	0	0	1	0	1	0	0	0	0	0	23	5	0	0	28	48
Apprch %	15.8	0	84.2	0		0	0	100	0		0	0	0	0		82.1	17.9	0	0		
Total %	6.2	0	33.3	0	39.6	0	0	2.1	0	2.1	0	0	0	0	0	47.9	10.4	0	0	58.3	

MEAD & HUNT

7055 Samuel Morse Dr. Ste. 100
Columbia, Maryland 21046
443-741-3500

File Name : paint branch dr at campus dr
Site Code : 00000000
Start Date : 9/19/2023
Page No : 2

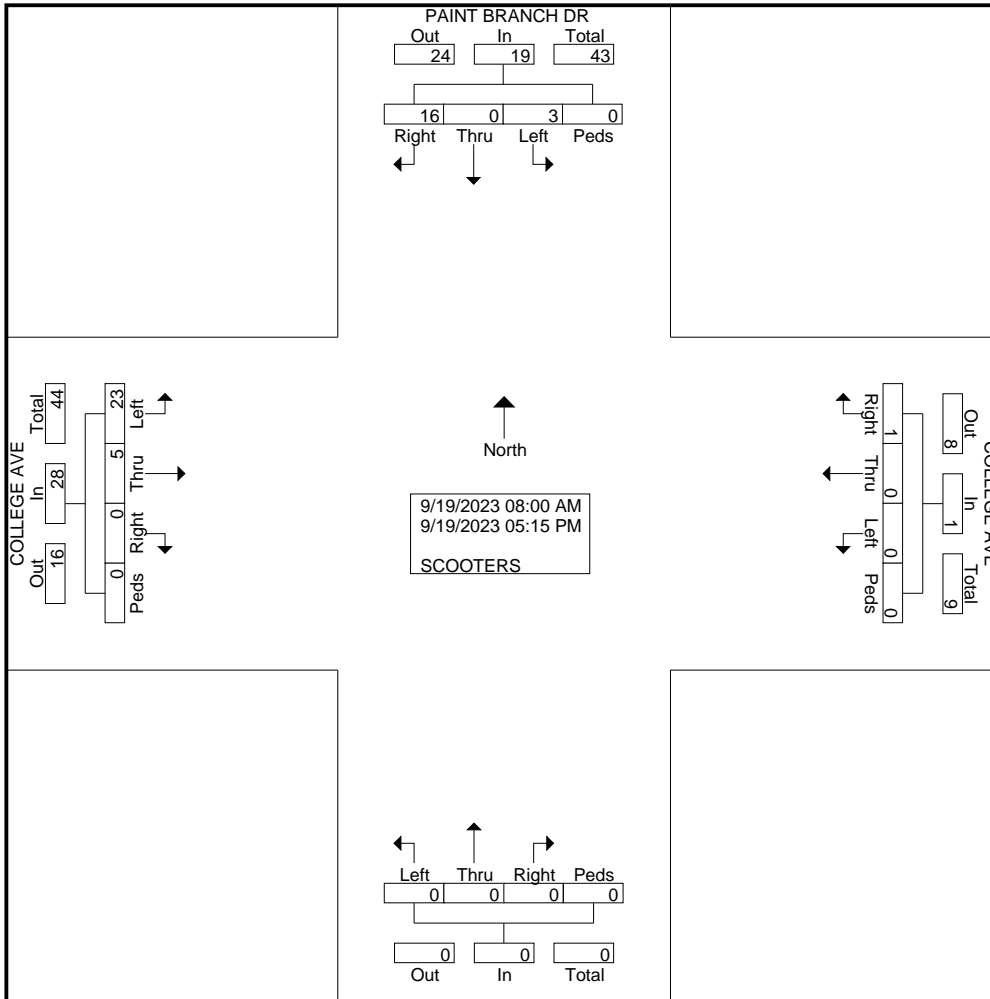

MEAD & HUNT

7055 Samuel Morse Dr. Ste. 100
Columbia, Maryland 21046

443-741-3500

Weather:
Counted By:
Town:
Country

File Name : paint branch dr at campus dr
Site Code : 00000000
Start Date : 9/19/2023
Page No : 1

Groups Printed- SKATEBOARDS

Start Time	PAINT BRANCH DR From North					COLLEGE AVE From East					From South					COLLEGE AVE From West					Int. Total
	Left	Thru	Right	Peds	App. Total	Left	Thru	Right	Peds	App. Total	Left	Thru	Right	Peds	App. Total	Left	Thru	Right	Peds	App. Total	
*** BREAK ***																					
03:30 PM	0	0	0	0	0	0	0	0	0	0	0	0	0	0	0	0	0	0	1	1	1
03:45 PM	0	0	0	0	0	0	0	0	0	0	0	0	0	0	0	0	0	0	3	3	3
Total	0	0	0	0	0	0	0	0	0	0	0	0	0	0	0	0	0	0	4	4	4
*** BREAK ***																					
04:30 PM	0	0	0	0	0	0	0	0	0	0	0	0	0	0	0	0	0	0	1	1	1
04:45 PM	0	0	0	0	0	0	0	0	0	0	0	0	0	0	0	0	0	0	1	1	1
Total	0	0	0	0	0	0	0	0	0	0	0	0	0	0	0	0	0	0	2	2	2
*** BREAK ***																					
Grand Total	0	0	0	0	0	0	0	0	0	0	0	0	0	0	0	0	0	0	6	6	6
Apprch %	0	0	0	0	0	0	0	0	0	0	0	0	0	0	0	0	0	0	100		
Total %	0	0	0	0	0	0	0	0	0	0	0	0	0	0	0	0	0	0	100	100	

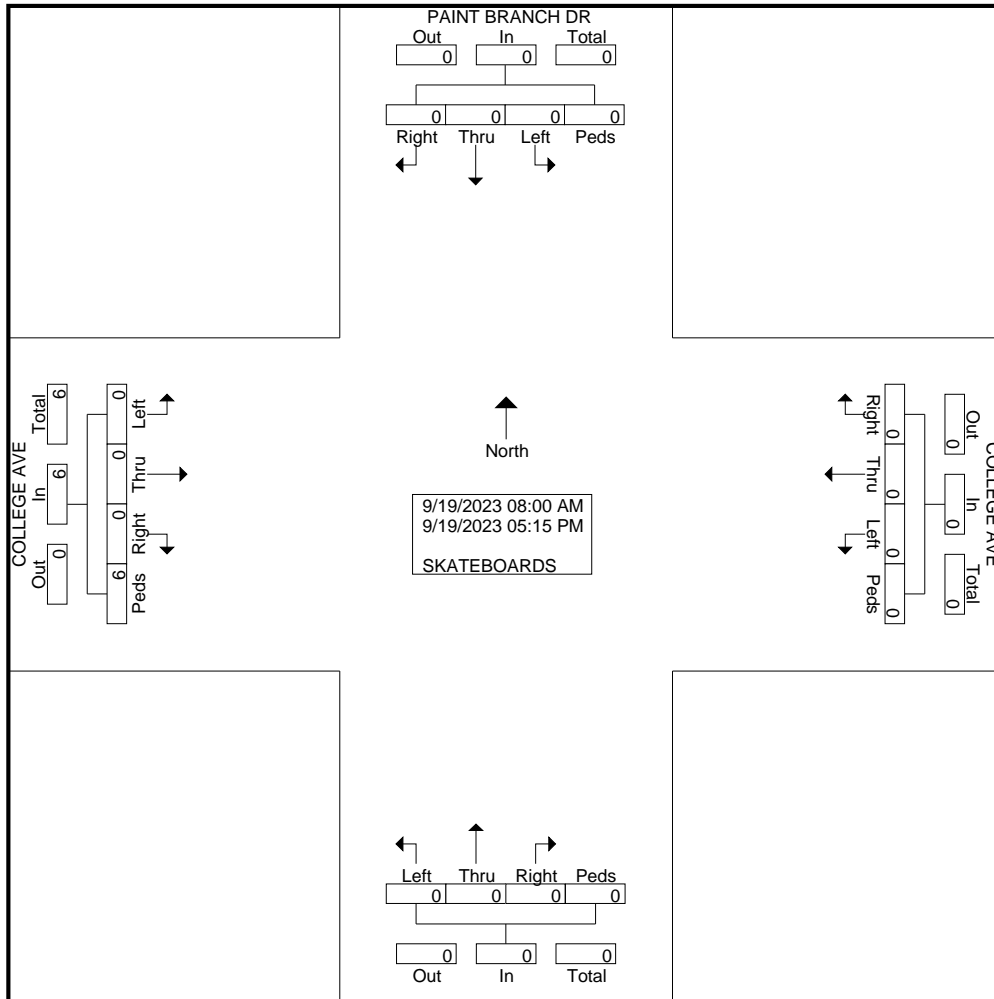

MEAD & HUNT

7055 Samuel Morse Dr. Ste. 100
Columbia, Maryland 21046

443-741-3500

MEAD & HUNT

7055 Samuel Morse Dr. Ste. 100
Columbia, Maryland 21046
443-741-3500

Weather:
Counted By:
Town:
Country

File Name : paint branch dr at campus dr
Site Code : 00000000
Start Date : 9/19/2023
Page No : 1

Groups Printed- BUSES

Start Time	PAINT BRANCH DR From North					COLLEGE AVE From East					From South					COLLEGE AVE From West					Int. Total
	Left	Thru	Right	Peds	App. Total	Left	Thru	Right	Peds	App. Total	Left	Thru	Right	Peds	App. Total	Left	Thru	Right	Peds	App. Total	
08:00 AM	0	0	0	0	0	0	5	3	0	8	0	0	0	0	0	1	0	0	0	1	9
08:15 AM	0	0	0	0	0	0	5	3	0	8	0	0	0	0	0	0	2	0	0	2	10
08:30 AM	2	0	0	0	2	0	4	1	0	5	0	0	0	0	0	1	1	0	0	2	9
08:45 AM	2	0	0	0	2	0	5	5	0	10	0	0	0	0	0	0	3	0	0	3	15
Total	4	0	0	0	4	0	19	12	0	31	0	0	0	0	0	2	6	0	0	8	43
09:00 AM	1	0	0	0	1	0	4	2	0	6	0	0	0	0	0	1	2	0	0	3	10
09:15 AM	1	0	0	0	1	0	7	5	0	12	0	0	0	0	0	1	1	0	0	2	15
09:30 AM	1	0	0	0	1	0	2	4	0	6	0	0	0	0	0	1	3	0	0	4	11
09:45 AM	1	0	1	0	2	0	8	2	0	10	0	0	0	0	0	1	3	0	0	4	16
Total	4	0	1	0	5	0	21	13	0	34	0	0	0	0	0	4	9	0	0	13	52
*** BREAK ***																					
03:30 PM	1	0	0	0	1	0	2	2	0	4	0	0	0	0	0	2	1	0	0	3	8
03:45 PM	2	0	0	0	2	0	7	3	0	10	0	0	0	0	0	2	5	0	0	7	19
Total	3	0	0	0	3	0	9	5	0	14	0	0	0	0	0	4	6	0	0	10	27
04:00 PM	0	0	0	0	0	0	6	4	0	10	0	0	0	0	0	0	3	0	0	3	13
04:15 PM	1	0	0	0	1	0	4	2	0	6	0	0	0	0	0	1	3	0	0	4	11
04:30 PM	1	0	0	0	1	0	4	3	0	7	0	0	0	0	0	0	1	0	0	1	9
04:45 PM	1	0	0	0	1	0	5	3	0	8	0	0	0	0	0	1	3	0	0	4	13
Total	3	0	0	0	3	0	19	12	0	31	0	0	0	0	0	2	10	0	0	12	46
05:00 PM	0	0	0	0	0	0	5	4	0	9	0	0	0	0	0	0	3	0	0	3	12
05:15 PM	1	0	0	0	1	0	3	3	0	6	0	0	0	0	0	1	3	0	0	4	11
Grand Total	15	0	1	0	16	0	76	49	0	125	0	0	0	0	0	13	37	0	0	50	191
Apprch %	93.8	0	6.2	0		0	60.8	39.2	0		0	0	0	0		26	74	0	0		
Total %	7.9	0	0.5	0	8.4	0	39.8	25.7	0	65.4	0	0	0	0		6.8	19.4	0	0	26.2	

MEAD & HUNT

7055 Samuel Morse Dr. Ste. 100
 Columbia, Maryland 21046
 443-741-3500

File Name : paint branch dr at campus dr
 Site Code : 00000000
 Start Date : 9/19/2023
 Page No : 2

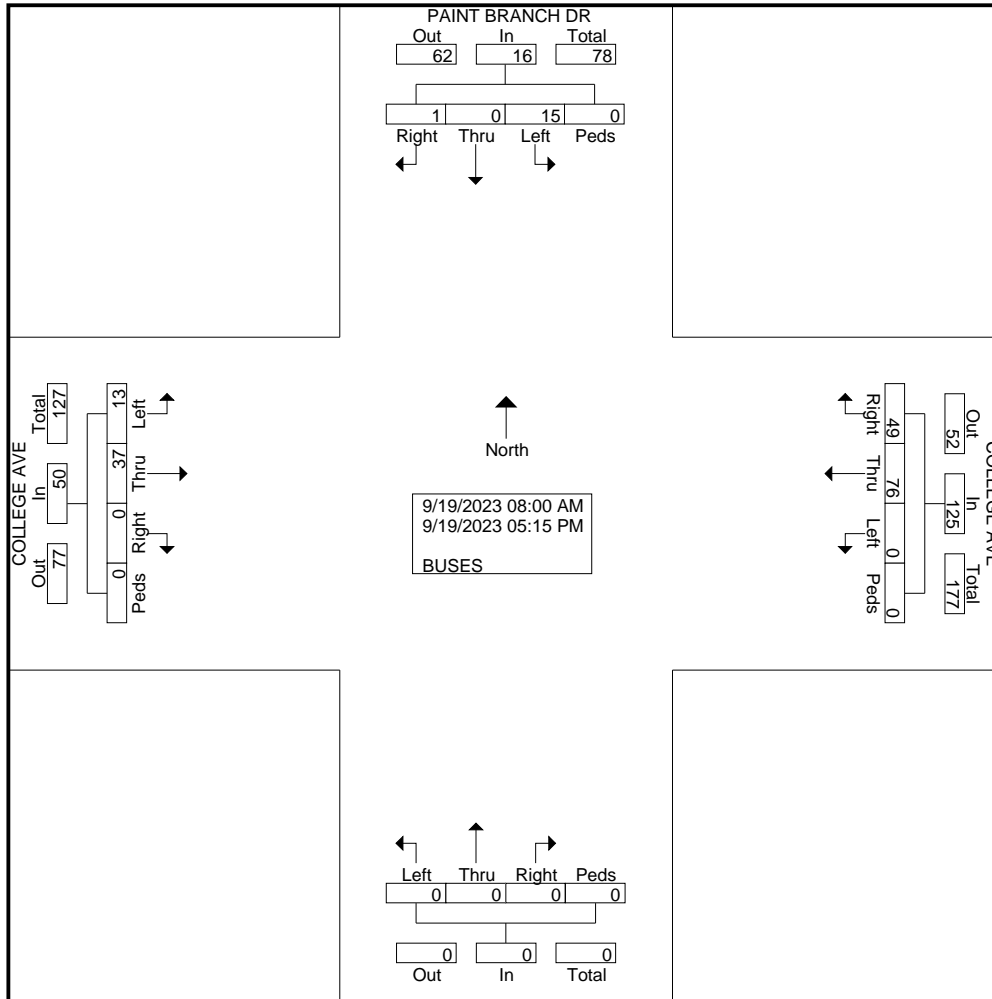

MEAD & HUNT

7055 Samuel Morse Dr. Ste. 100
Columbia, Maryland 21046
443-741-3500

File Name : paint branch dr at campus dr
Site Code : 00000000
Start Date : 9/19/2023
Page No : 3

Start Time	PAINT BRANCH DR From North					COLLEGE AVE From East					From South					COLLEGE AVE From West					Int. Total
	Left	Thru	Right	Peds	App. Total	Left	Thru	Right	Peds	App. Total	Left	Thru	Right	Peds	App. Total	Left	Thru	Right	Peds	App. Total	
Peak Hour Analysis From 08:00 AM to 11:45 AM - Peak 1 of 1																					
Peak Hour for Entire Intersection Begins at 09:00 AM																					
09:00 AM	1	0	0	0	1	0	4	2	0	6	0	0	0	0	0	1	2	0	0	3	10
09:15 AM	1	0	0	0	1	0	7	5	0	12	0	0	0	0	0	1	1	0	0	2	15
09:30 AM	1	0	0	0	1	0	2	4	0	6	0	0	0	0	0	1	3	0	0	4	11
09:45 AM	1	0	1	0	2	0	8	2	0	10	0	0	0	0	0	1	3	0	0	4	16
Total Volume	4	0	1	0	5	0	21	13	0	34	0	0	0	0	0	4	9	0	0	13	52
% App. Total	80	0	20	0		0	61.8	38.2	0		0	0	0	0		30.8	69.2	0	0		
PHF	1.00	.000	.250	.000	.625	.000	.656	.650	.000	.708	.000	.000	.000	.000	.000	1.00	.750	.000	.000	.813	.813

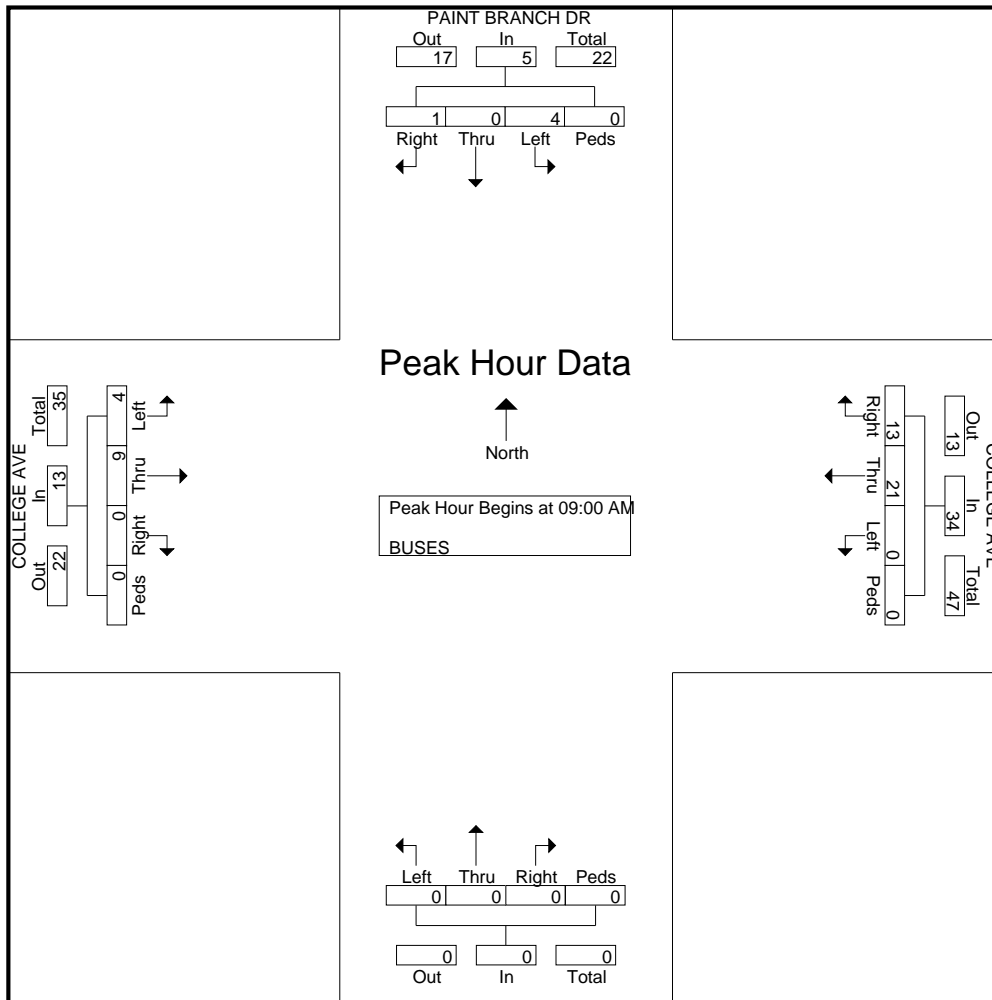

MEAD & HUNT

7055 Samuel Morse Dr. Ste. 100
Columbia, Maryland 21046
443-741-3500

File Name : paint branch dr at campus dr
Site Code : 00000000
Start Date : 9/19/2023
Page No : 4

Start Time	PAINT BRANCH DR From North					COLLEGE AVE From East					From South					COLLEGE AVE From West					Int. Total
	Left	Thru	Right	Peds	App. Total	Left	Thru	Right	Peds	App. Total	Left	Thru	Right	Peds	App. Total	Left	Thru	Right	Peds	App. Total	

Peak Hour Analysis From 12:00 PM to 05:15 PM - Peak 1 of 1

Peak Hour for Entire Intersection Begins at 03:45 PM

03:45 PM	2	0	0	0	2	0	7	3	0	10	0	0	0	0	0	2	5	0	0	7	19
04:00 PM	0	0	0	0	0	0	6	4	0	10	0	0	0	0	0	0	3	0	0	3	13
04:15 PM	1	0	0	0	1	0	4	2	0	6	0	0	0	0	0	1	3	0	0	4	11
04:30 PM	1	0	0	0	1	0	4	3	0	7	0	0	0	0	0	0	1	0	0	1	9
Total Volume	4	0	0	0	4	0	21	12	0	33	0	0	0	0	0	3	12	0	0	15	52
% App. Total	100	0	0	0		0	63.6	36.4	0		0	0	0	0		20	80	0	0		
PHF	.500	.000	.000	.000	.500	.000	.750	.750	.000	.825	.000	.000	.000	.000	.000	.375	.600	.000	.000	.536	.684

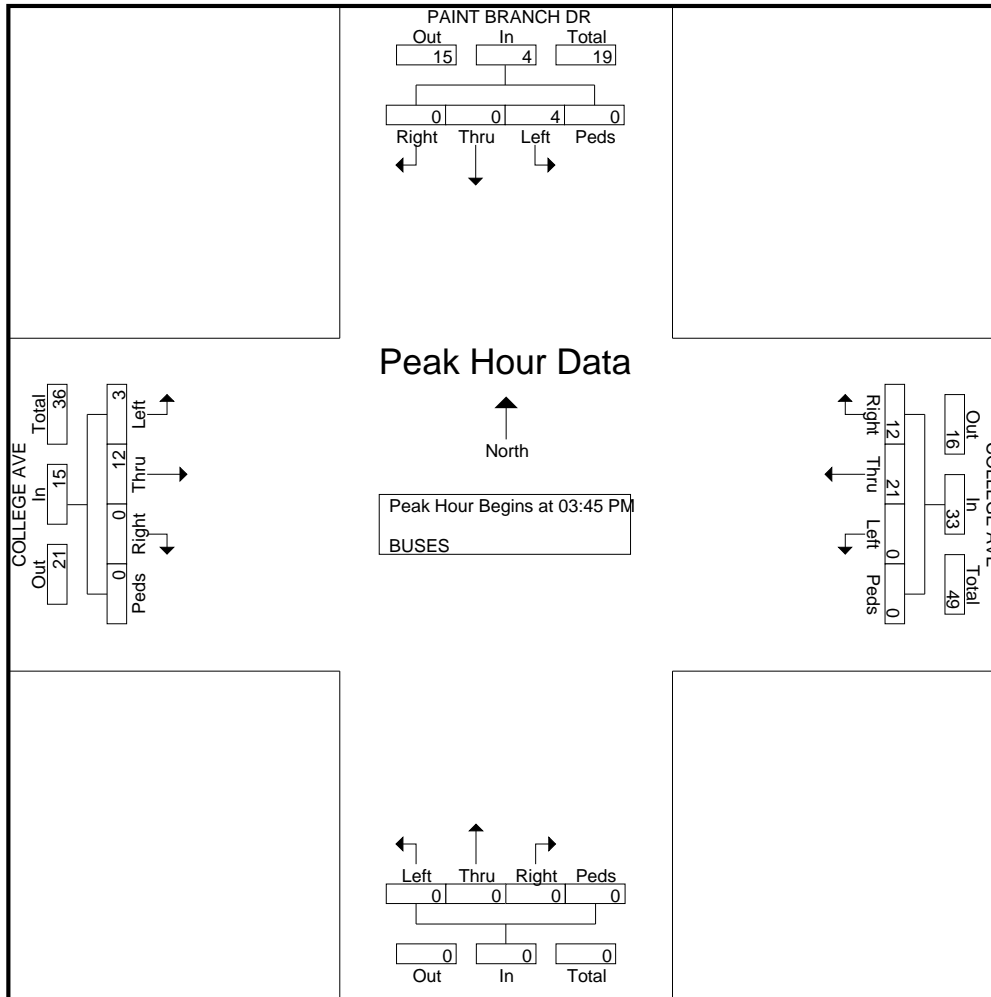

MEAD & HUNT

7055 Samuel Morse Dr. Ste. 100
Columbia, Maryland 21046

443-741-3500

Weather:
Counted By:
Town:
Country

File Name : paint branch dr at campus dr
Site Code : 00000000
Start Date : 9/19/2023
Page No : 1

Groups Printed- U TURNS

Start Time	PAINT BRANCH DR From North					COLLEGE AVE From East					From South					COLLEGE AVE From West					Int. Total
	Left	Thru	Right	Peds	App. Total	Left	Thru	Right	Peds	App. Total	Left	Thru	Right	Peds	App. Total	Left	Thru	Right	Peds	App. Total	
08:00 AM	0	0	0	0	0	1	0	0	0	1	0	0	0	0	0	0	0	0	0	0	1
*** BREAK ***																					
08:45 AM	0	0	0	0	0	3	0	0	0	3	0	0	0	0	0	0	0	0	0	0	3
Total	0	0	0	0	0	4	0	0	0	4	0	0	0	0	0	0	0	0	0	0	4
*** BREAK ***																					
03:45 PM	0	0	0	0	0	1	0	0	0	1	0	0	0	0	0	0	0	0	0	0	1
Total	0	0	0	0	0	1	0	0	0	1	0	0	0	0	0	0	0	0	0	0	1
*** BREAK ***																					
04:45 PM	0	0	0	0	0	1	0	0	0	1	0	0	0	0	0	0	0	0	0	0	1
Total	0	0	0	0	0	1	0	0	0	1	0	0	0	0	0	0	0	0	0	0	1
*** BREAK ***																					
Grand Total	0	0	0	0	0	6	0	0	0	6	0	0	0	0	0	0	0	0	0	0	6
Apprch %	0	0	0	0	0	100	0	0	0	100	0	0	0	0	0	0	0	0	0	0	
Total %	0	0	0	0	0	100	0	0	0	100	0	0	0	0	0	0	0	0	0	0	

MEAD & HUNT

7055 Samuel Morse Dr. Ste. 100
Columbia, Maryland 21046

443-741-3500

File Name : paint branch dr at campus dr

Site Code : 00000000

Start Date : 9/19/2023

Page No : 2

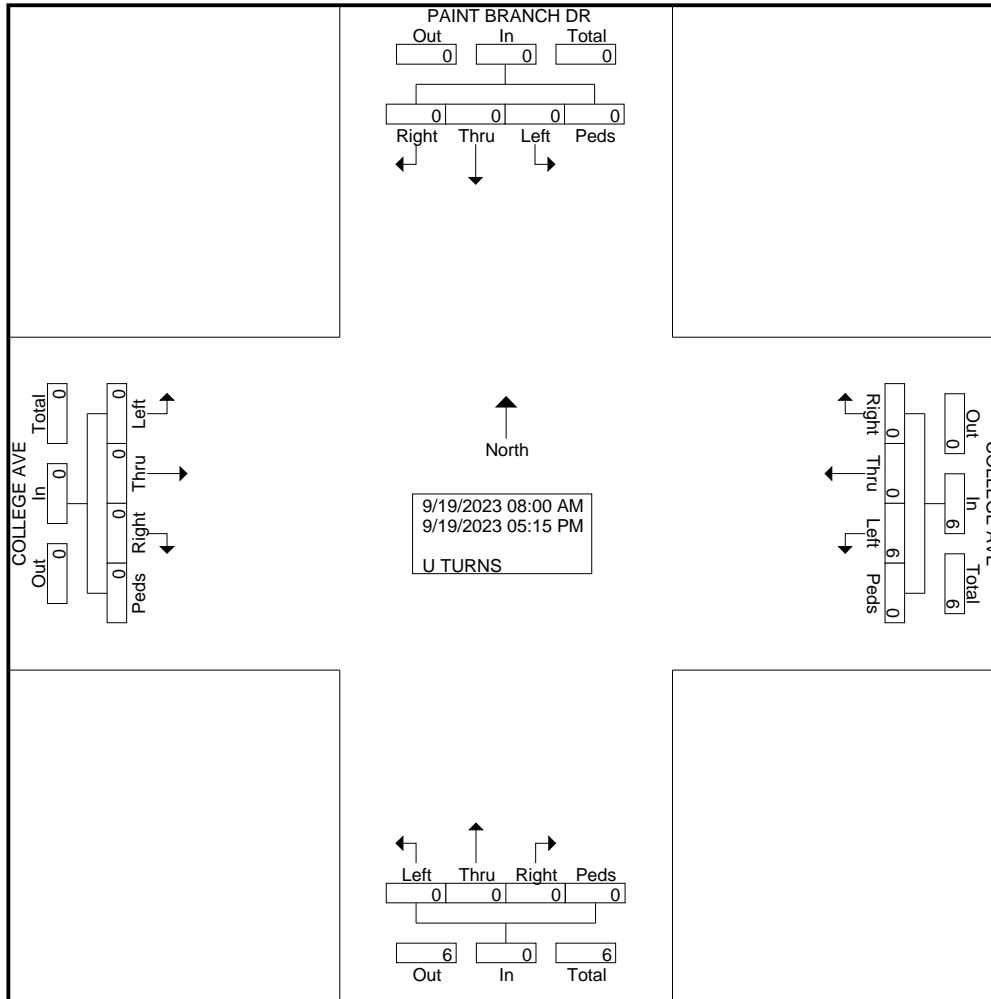

MEAD & HUNT

7055 Samuel Morse Dr. Ste. 100

Columbia, Maryland 21046

443-741-3500

Weather:
Counted By:
Town:
Country

File Name : preinkert at campus dr
Site Code : 00000000
Start Date : 9/19/2023
Page No : 1

Groups Printed- VEHS&PEDS

Start Time	PREINKERT DR From North					From East					PREINKERT DR From South					COLLEGE AVE From West					Int. Total
	Left	Thru	Right	Peds	App. Total	Left	Thru	Right	Peds	App. Total	Left	Thru	Right	Peds	App. Total	Left	Thru	Right	Peds	App. Total	
08:00 AM	0	13	16	0	29	0	0	0	0	0	6	5	0	2	13	10	0	20	2	32	74
08:15 AM	0	13	14	0	27	0	0	0	0	0	6	1	0	6	13	8	0	10	6	24	64
08:30 AM	0	13	13	0	26	0	0	0	0	0	6	1	0	2	9	2	0	13	4	19	54
08:45 AM	0	13	18	1	32	0	0	0	0	0	7	3	0	1	11	5	0	13	25	43	86
Total	0	52	61	1	114	0	0	0	0	0	25	10	0	11	46	25	0	56	37	118	278
09:00 AM	0	10	14	0	24	0	0	0	0	0	11	4	0	1	16	6	0	13	18	37	77
09:15 AM	0	11	16	4	31	0	0	0	0	0	5	4	0	22	31	8	0	16	107	131	193
09:30 AM	0	15	24	2	41	0	0	0	0	0	15	6	0	20	41	5	0	16	44	65	147
09:45 AM	0	16	16	2	34	0	0	0	0	0	9	5	0	9	23	7	0	14	11	32	89
Total	0	52	70	8	130	0	0	0	0	0	40	19	0	52	111	26	0	59	180	265	506
*** BREAK ***																					
03:30 PM	0	21	18	0	39	0	0	0	0	0	15	3	0	21	39	4	0	12	23	39	117
03:45 PM	0	13	17	3	33	0	0	0	0	0	9	4	0	4	17	0	0	13	29	42	92
Total	0	34	35	3	72	0	0	0	0	0	24	7	0	25	56	4	0	25	52	81	209
04:00 PM	0	12	12	1	25	0	0	0	0	0	10	1	0	20	31	6	0	20	14	40	96
04:15 PM	0	12	17	1	30	0	0	0	0	0	18	0	0	11	29	7	0	10	21	38	97
04:30 PM	0	9	13	3	25	0	0	0	0	0	15	2	0	15	32	8	0	4	26	38	95
04:45 PM	0	12	9	2	23	0	0	0	0	0	13	2	0	32	47	2	0	11	74	87	157
Total	0	45	51	7	103	0	0	0	0	0	56	5	0	78	139	23	0	45	135	203	445
05:00 PM	0	13	17	2	32	0	0	0	0	0	20	1	0	6	27	10	0	12	20	42	101
05:15 PM	0	11	18	1	30	0	0	0	0	0	10	4	0	8	22	1	0	17	18	36	88
Grand Total	0	207	252	22	481	0	0	0	0	0	175	46	0	180	401	89	0	214	442	745	1627
Apprch %	0	43	52.4	4.6		0	0	0	0		43.6	11.5	0	44.9		11.9	0	28.7	59.3		
Total %	0	12.7	15.5	1.4	29.6	0	0	0	0	0	10.8	2.8	0	11.1	24.6	5.5	0	13.2	27.2	45.8	

MEAD & HUNT

7055 Samuel Morse Dr. Ste. 100
Columbia, Maryland 21046

443-741-3500

File Name : preinkert at campus dr

Site Code : 00000000

Start Date : 9/19/2023

Page No : 2

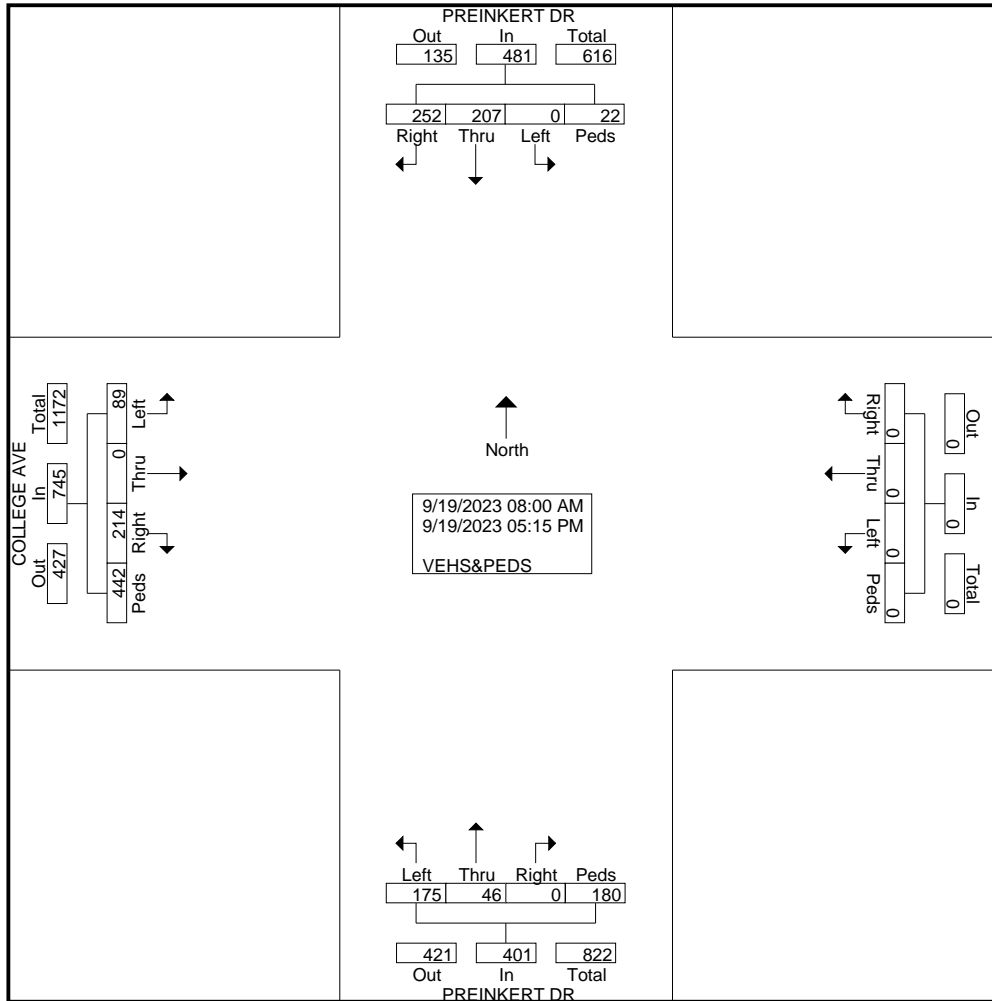

MEAD & HUNT

7055 Samuel Morse Dr. Ste. 100
Columbia, Maryland 21046

443-741-3500

File Name : preinkert at campus dr

Site Code : 00000000

Start Date : 9/19/2023

Page No : 3

Start Time	PREINKERT DR From North					From East					PREINKERT DR From South					COLLEGE AVE From West					Int. Total
	Left	Thru	Right	Peds	App. Total	Left	Thru	Right	Peds	App. Total	Left	Thru	Right	Peds	App. Total	Left	Thru	Right	Peds	App. Total	
Peak Hour Analysis From 08:00 AM to 12:45 PM - Peak 1 of 1																					
Peak Hour for Entire Intersection Begins at 09:00 AM																					
09:00 AM	0	10	14	0	24	0	0	0	0	0	11	4	0	1	16	6	0	13	18	37	77
09:15 AM	0	11	16	4	31	0	0	0	0	0	5	4	0	22	31	8	0	16	107	131	193
09:30 AM	0	15	24	2	41	0	0	0	0	0	15	6	0	20	41	5	0	16	44	65	147
09:45 AM	0	16	16	2	34	0	0	0	0	0	9	5	0	9	23	7	0	14	11	32	89
Total Volume	0	52	70	8	130	0	0	0	0	0	40	19	0	52	111	26	0	59	180	265	506
% App. Total	0	40	53.8	6.2		0	0	0	0		36	17.1	0	46.8		9.8	0	22.3	67.9		
PHF	.000	.813	.729	.500	.793	.000	.000	.000	.000	.000	.667	.792	.000	.591	.677	.813	.000	.922	.421	.506	.655

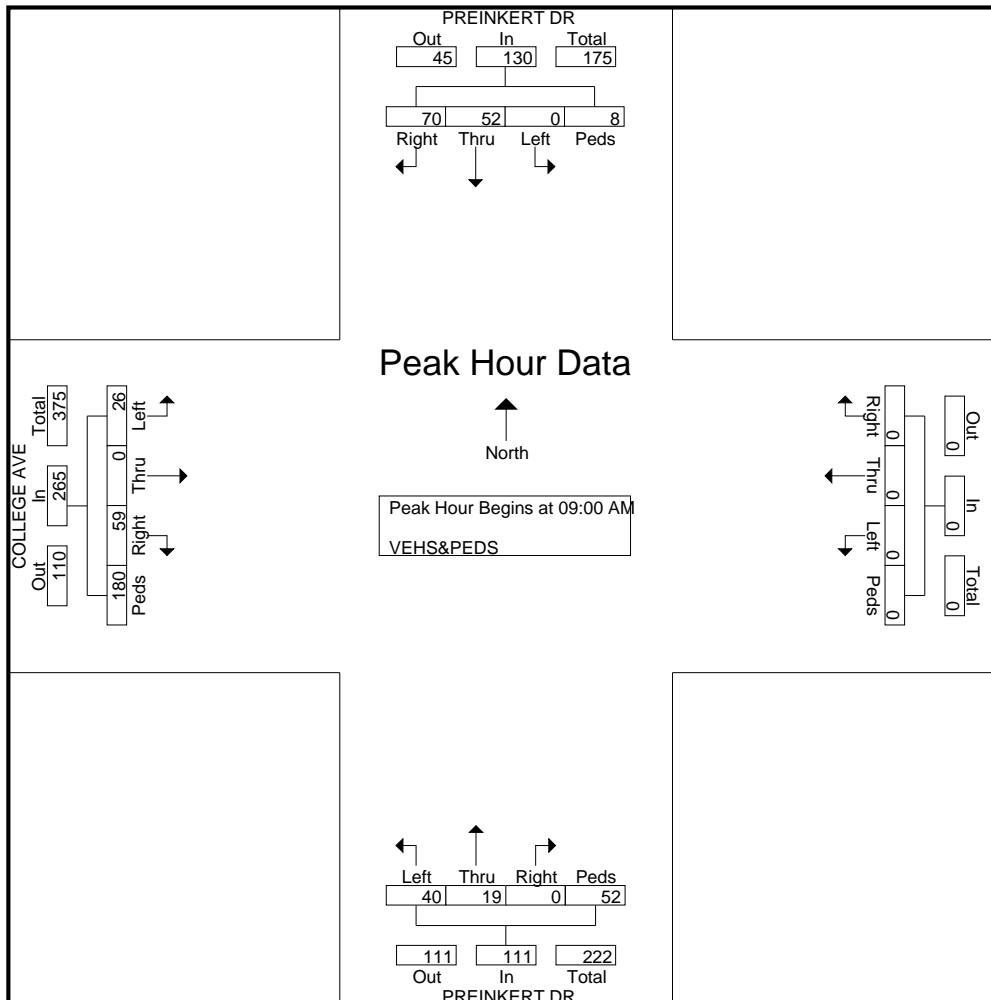

MEAD & HUNT

7055 Samuel Morse Dr. Ste. 100
Columbia, Maryland 21046
443-741-3500

File Name : preinkert at campus dr
Site Code : 00000000
Start Date : 9/19/2023
Page No : 4

Start Time	PREINKERT DR From North					From East					PREINKERT DR From South					COLLEGE AVE From West					Int. Total
	Left	Thru	Right	Peds	App. Total	Left	Thru	Right	Peds	App. Total	Left	Thru	Right	Peds	App. Total	Left	Thru	Right	Peds	App. Total	

Peak Hour Analysis From 01:00 PM to 05:15 PM - Peak 1 of 1

Peak Hour for Entire Intersection Begins at 04:15 PM

04:15 PM	0	12	17	1	30	0	0	0	0	0	18	0	0	11	29	7	0	10	21	38	97
04:30 PM	0	9	13	3	25	0	0	0	0	0	15	2	0	15	32	8	0	4	26	38	95
04:45 PM	0	12	9	2	23	0	0	0	0	0	13	2	0	32	47	2	0	11	74	87	157
05:00 PM	0	13	17	2	32	0	0	0	0	0	20	1	0	6	27	10	0	12	20	42	101
Total Volume	0	46	56	8	110	0	0	0	0	0	66	5	0	64	135	27	0	37	141	205	450
% App. Total	0	41.8	50.9	7.3		0	0	0	0		48.9	3.7	0	47.4		13.2	0	18	68.8		
PHF	.000	.885	.824	.667	.859	.000	.000	.000	.000	.000	.825	.625	.000	.500	.718	.675	.000	.771	.476	.589	.717

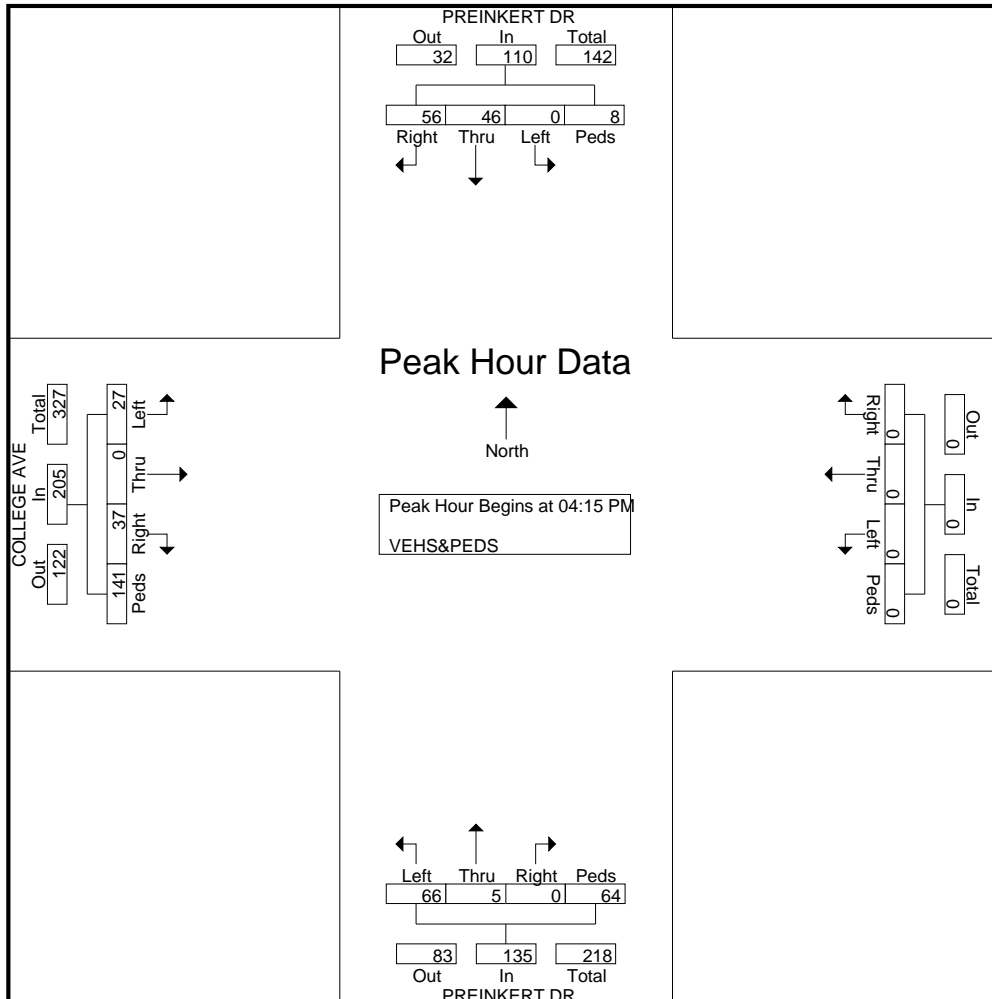

MEAD & HUNT

7055 Samuel Morse Dr. Ste. 100
Columbia, Maryland 21046
443-741-3500

Weather:
Counted By:
Town:
Country

File Name : preinkert at campus dr
Site Code : 00000000
Start Date : 9/19/2023
Page No : 1

Groups Printed- BICYCLES

Start Time	PREINKERT DR From North					From East					PREINKERT DR From South					COLLEGE AVE From West					Int. Total
	Left	Thru	Right	Peds	App. Total	Left	Thru	Right	Peds	App. Total	Left	Thru	Right	Peds	App. Total	Left	Thru	Right	Peds	App. Total	
08:00 AM	0	1	0	0	1	0	0	0	0	0	0	0	0	0	0	0	0	1	0	1	2
08:15 AM	0	0	0	0	0	0	0	0	0	0	0	1	0	1	2	0	0	1	1	2	4
08:30 AM	0	0	0	0	0	0	0	0	0	0	0	0	0	0	0	0	0	1	0	1	1
08:45 AM	0	1	0	0	1	0	0	0	0	0	0	0	0	0	0	3	0	1	0	4	5
Total	0	2	0	0	2	0	0	0	0	0	0	1	0	1	2	3	0	4	1	8	12
09:00 AM	0	0	0	0	0	0	0	0	0	0	1	2	0	0	3	0	0	0	2	2	5
09:15 AM	0	0	0	0	0	0	0	0	0	0	0	3	0	0	3	2	0	1	1	4	7
09:30 AM	0	0	0	1	1	0	0	0	0	0	0	2	0	2	4	0	0	0	4	4	9
09:45 AM	0	0	0	0	0	0	0	0	0	0	1	2	0	1	4	0	0	1	0	1	5
Total	0	0	0	1	1	0	0	0	0	0	2	9	0	3	14	2	0	2	7	11	26
*** BREAK ***																					
03:30 PM	0	1	2	0	3	0	0	0	0	0	1	1	0	7	9	0	0	2	0	2	14
03:45 PM	0	0	0	1	1	0	0	0	0	0	1	1	0	5	7	0	0	0	0	0	8
Total	0	1	2	1	4	0	0	0	0	0	2	2	0	12	16	0	0	2	0	2	22
04:00 PM	0	1	0	0	1	0	0	0	0	0	1	1	0	1	3	0	0	0	0	0	4
04:15 PM	0	0	0	0	0	0	0	0	0	0	1	0	0	0	1	0	0	0	0	0	1
04:30 PM	0	2	1	0	3	0	0	0	0	0	3	0	0	0	3	0	0	0	0	0	6
04:45 PM	0	2	1	0	3	0	0	0	0	0	1	2	0	0	3	1	0	0	0	1	7
Total	0	5	2	0	7	0	0	0	0	0	6	3	0	1	10	1	0	0	0	1	18
05:00 PM	0	1	3	0	4	0	0	0	0	0	1	1	0	0	2	0	0	1	0	1	7
05:15 PM	0	1	3	0	4	0	0	0	0	0	3	1	0	0	4	0	0	0	0	0	8
Grand Total	0	10	10	2	22	0	0	0	0	0	14	17	0	17	48	6	0	9	8	23	93
Apprch %	0	45.5	45.5	9.1		0	0	0	0		29.2	35.4	0	35.4		26.1	0	39.1	34.8		
Total %	0	10.8	10.8	2.2	23.7	0	0	0	0	0	15.1	18.3	0	18.3	51.6	6.5	0	9.7	8.6	24.7	

MEAD & HUNT

7055 Samuel Morse Dr. Ste. 100
Columbia, Maryland 21046

443-741-3500

File Name : preinkert at campus dr

Site Code : 00000000

Start Date : 9/19/2023

Page No : 2

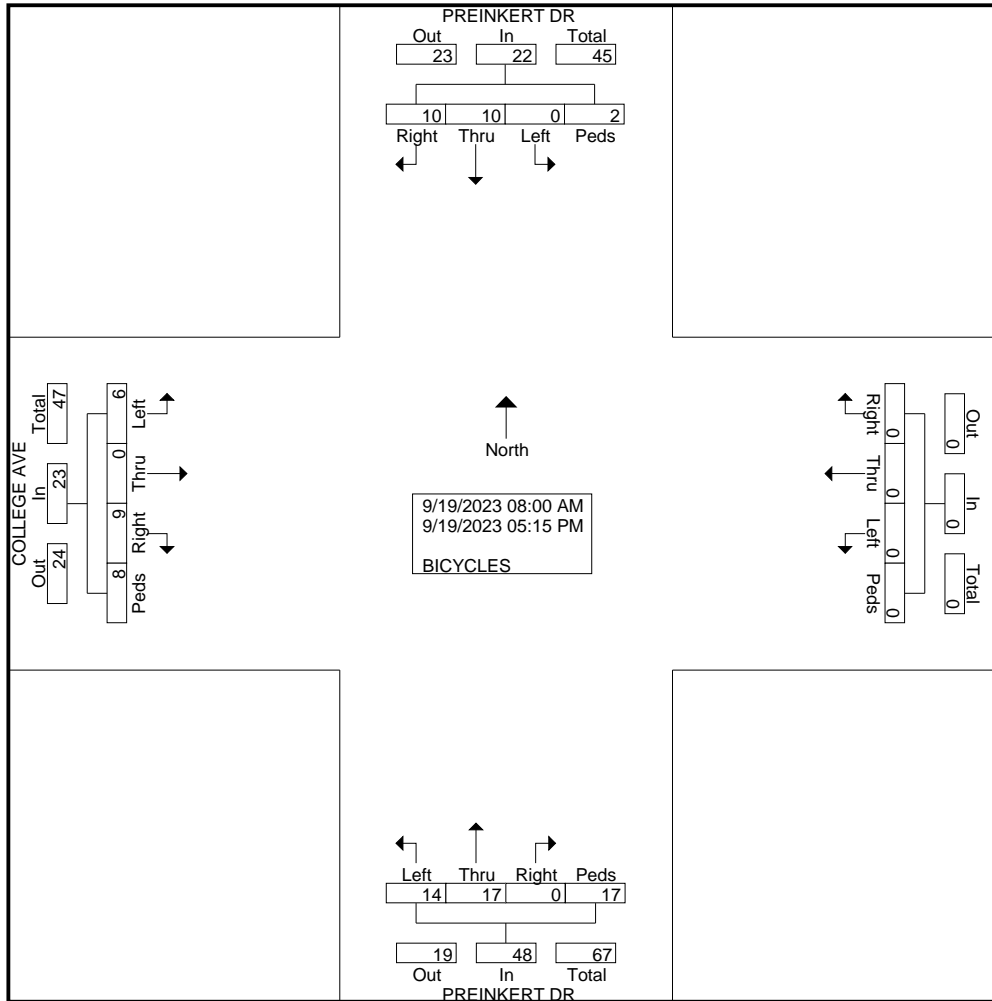

MEAD & HUNT

7055 Samuel Morse Dr. Ste. 100

Columbia, Maryland 21046

443-741-3500

Weather:
Counted By:
Town:
Country

File Name : preinkert at campus dr
Site Code : 00000000
Start Date : 9/19/2023
Page No : 1

Groups Printed- SCOOTERS

Start Time	PREINKERT DR From North					From East					PREINKERT DR From South					COLLEGE AVE From West					Int. Total
	Left	Thru	Right	Peds	App. Total	Left	Thru	Right	Peds	App. Total	Left	Thru	Right	Peds	App. Total	Left	Thru	Right	Peds	App. Total	
08:00 AM	0	0	0	0	0	0	0	0	0	0	0	2	0	0	2	0	0	1	0	1	3
08:15 AM	0	0	0	0	0	0	0	0	0	0	1	4	0	0	5	0	0	1	0	1	6
08:30 AM	0	0	0	0	0	0	0	0	0	0	0	3	0	0	3	1	0	0	0	1	4
08:45 AM	0	0	0	0	0	0	0	0	0	0	0	5	0	0	5	0	0	3	0	3	8
Total	0	0	0	0	0	0	0	0	0	0	1	14	0	0	15	1	0	5	0	6	21
09:00 AM	0	2	0	0	2	0	0	0	0	0	0	2	0	0	2	0	0	1	0	1	5
09:15 AM	0	0	0	0	0	0	0	0	0	0	2	7	0	0	9	1	0	2	0	3	12
09:30 AM	0	0	1	0	1	0	0	0	0	0	1	5	0	0	6	1	0	2	0	3	10
09:45 AM	0	0	1	0	1	0	0	0	0	0	1	3	0	0	4	0	0	3	0	3	8
Total	0	2	2	0	4	0	0	0	0	0	4	17	0	0	21	2	0	8	0	10	35
*** BREAK ***																					
03:30 PM	0	3	3	0	6	0	0	0	0	0	1	2	0	0	3	2	0	0	0	2	11
03:45 PM	0	0	0	0	0	0	0	0	0	0	3	3	0	0	6	1	0	2	0	3	9
Total	0	3	3	0	6	0	0	0	0	0	4	5	0	0	9	3	0	2	0	5	20
04:00 PM	0	1	0	0	1	0	0	0	0	0	1	3	0	0	4	2	0	0	0	2	7
04:15 PM	0	2	0	0	2	0	0	0	0	0	0	1	0	0	1	2	0	0	0	2	5
04:30 PM	0	4	2	0	6	0	0	0	0	0	0	1	0	0	1	1	0	0	0	1	8
04:45 PM	0	3	4	0	7	0	0	0	0	0	2	3	0	0	5	2	0	0	0	2	14
Total	0	10	6	0	16	0	0	0	0	0	3	8	0	0	11	7	0	0	0	7	34
05:00 PM	0	0	0	0	0	0	0	0	0	0	2	4	0	0	6	0	0	1	0	1	7
05:15 PM	0	1	0	0	1	0	0	0	0	0	0	2	0	0	2	0	0	3	0	3	6
Grand Total	0	16	11	0	27	0	0	0	0	0	14	50	0	0	64	13	0	19	0	32	123
Apprch %	0	59.3	40.7	0		0	0	0	0		21.9	78.1	0	0		40.6	0	59.4	0		
Total %	0	13	8.9	0	22	0	0	0	0	0	11.4	40.7	0	0	52	10.6	0	15.4	0	26	

MEAD & HUNT

7055 Samuel Morse Dr. Ste. 100
Columbia, Maryland 21046

443-741-3500

File Name : preinkert at campus dr

Site Code : 00000000

Start Date : 9/19/2023

Page No : 2

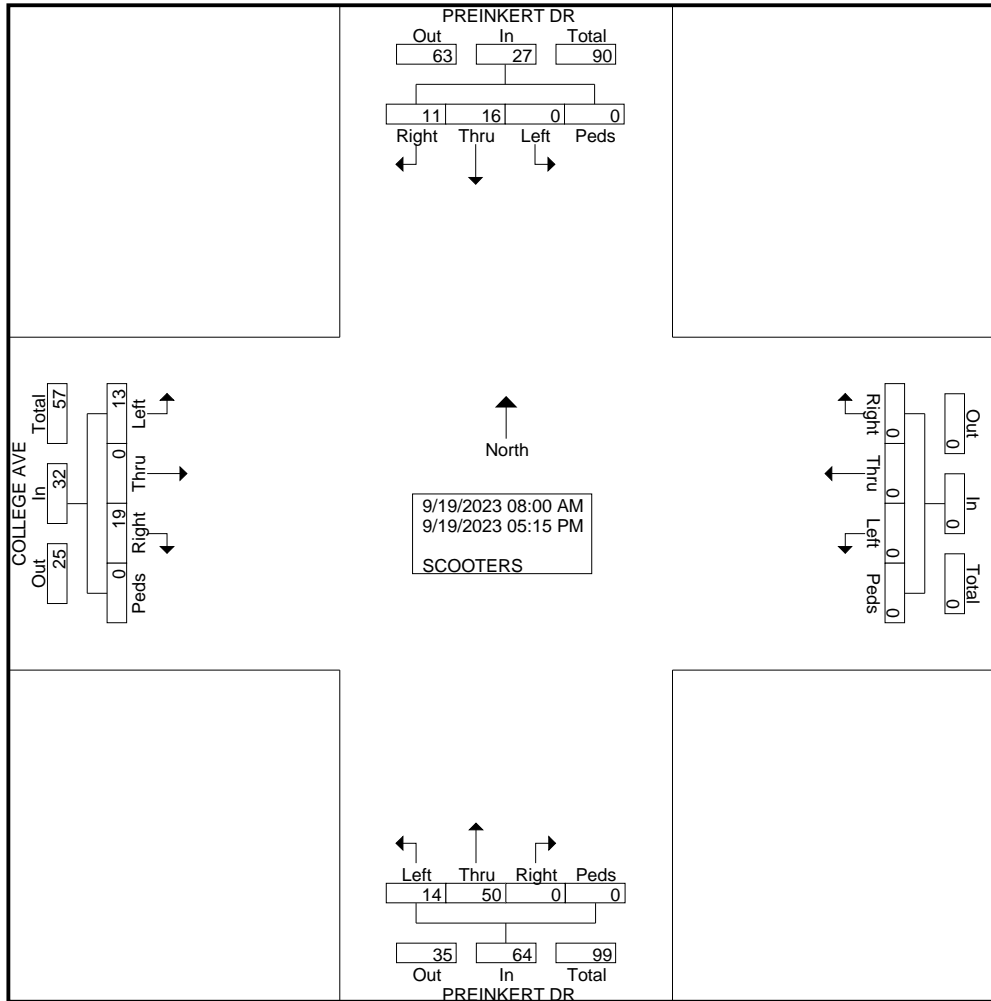

MEAD & HUNT

7055 Samuel Morse Dr. Ste. 100
Columbia, Maryland 21046
443-741-3500

Weather:
Counted By:
Town:
Country

File Name : preinkert at campus dr
Site Code : 00000000
Start Date : 9/19/2023
Page No : 1

Groups Printed- SKATEBOARDS

Start Time	PREINKERT DR From North					From East					PREINKERT DR From South					COLLEGE AVE From West					Int. Total
	Left	Thru	Right	Peds	App. Total	Left	Thru	Right	Peds	App. Total	Left	Thru	Right	Peds	App. Total	Left	Thru	Right	Peds	App. Total	
04:15 PM	0	0	0	0	0	0	0	0	0	0	0	0	0	1	1	0	0	0	0	0	1
*** BREAK ***																					
Total	0	0	0	0	0	0	0	0	0	0	0	0	0	1	1	0	0	0	0	0	1
*** BREAK ***																					
Grand Total	0	0	0	0	0	0	0	0	0	0	0	0	0	1	1	0	0	0	0	0	1
Apprch %	0	0	0	0	0	0	0	0	0	0	0	0	0	100	100	0	0	0	0	0	
Total %	0	0	0	0	0	0	0	0	0	0	0	0	0	100	100	0	0	0	0	0	

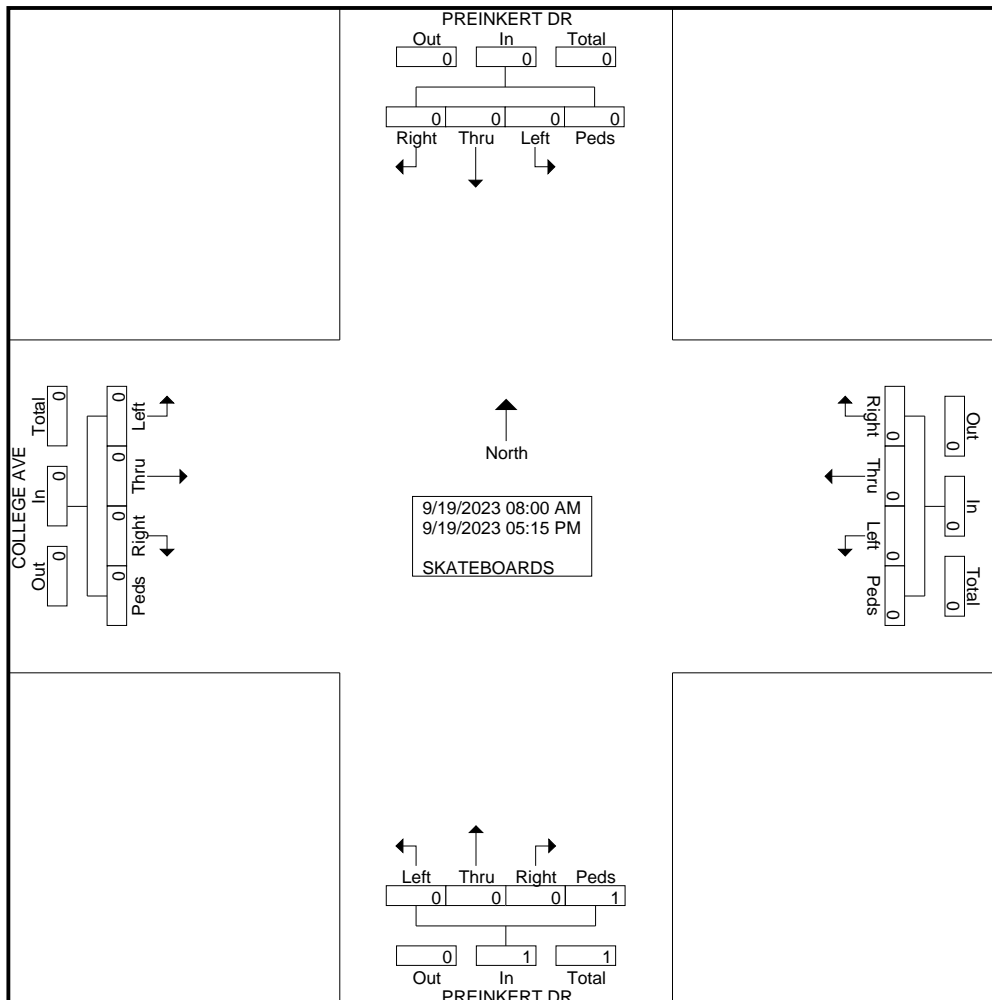

MEAD & HUNT

7055 Samuel Morse Dr. Ste. 100
 Columbia, Maryland 21046
 443-741-3500

Weather:
 Counted By:
 Town:
 Country

File Name : preinkert at campus dr
 Site Code : 00000000
 Start Date : 9/19/2023
 Page No : 1

Groups Printed- U TURNS

Start Time	PREINKERT DR From North					From East					PREINKERT DR From South					COLLEGE AVE From West					Int. Total
	Left	Thru	Right	Peds	App. Total	Left	Thru	Right	Peds	App. Total	Left	Thru	Right	Peds	App. Total	Left	Thru	Right	Peds	App. Total	
*** BREAK ***																					
08:30 AM	0	0	0	0	0	0	0	0	0	0	0	0	0	0	0	1	0	0	0	1	1
08:45 AM	0	0	0	0	0	0	0	0	0	0	0	0	0	0	0	1	0	0	0	1	1
Total	0	0	0	0	0	0	0	0	0	0	0	0	0	0	0	2	0	0	0	2	2
*** BREAK ***																					
09:30 AM	0	0	0	0	0	0	0	0	0	0	0	0	0	0	0	1	0	0	0	1	1
*** BREAK ***																					
Total	0	0	0	0	0	0	0	0	0	0	0	0	0	0	0	1	0	0	0	1	1
*** BREAK ***																					
03:30 PM	0	0	0	0	0	0	0	0	0	0	0	0	0	0	0	1	0	0	0	1	1
*** BREAK ***																					
Total	0	0	0	0	0	0	0	0	0	0	0	0	0	0	0	1	0	0	0	1	1
*** BREAK ***																					
Grand Total	0	0	0	0	0	0	0	0	0	0	0	0	0	0	0	4	0	0	0	4	4
Apprch %	0	0	0	0		0	0	0	0		0	0	0	0		100	0	0	0		
Total %	0	0	0	0		0	0	0	0		0	0	0	0		100	0	0	0	100	

MEAD & HUNT

7055 Samuel Morse Dr. Ste. 100
Columbia, Maryland 21046

443-741-3500

File Name : preinkert at campus dr

Site Code : 00000000

Start Date : 9/19/2023

Page No : 2

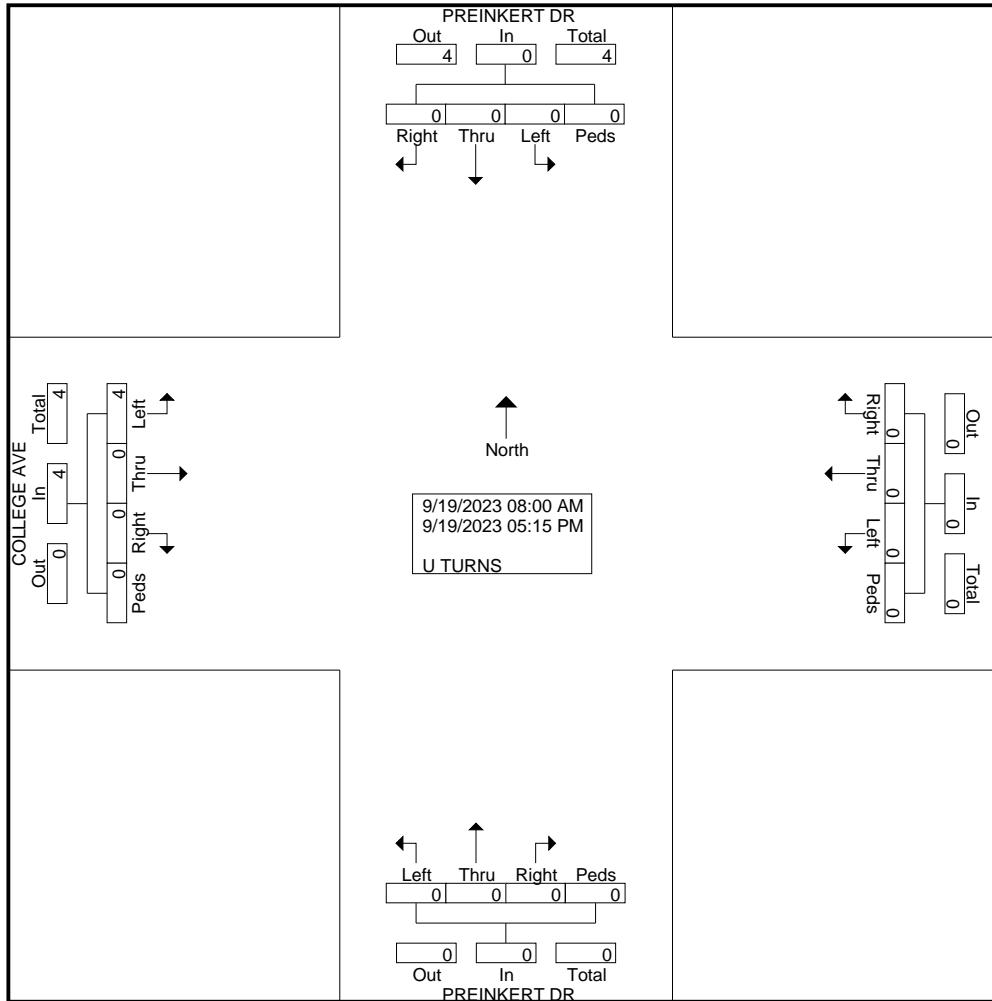

MEAD & HUNT

7055 Samuel Morse Dr. Ste. 100
Columbia, Maryland 21046

443-741-3500

Weather:
Counted By:
Town:
Country

File Name : preinkert at campus dr
Site Code : 00000000
Start Date : 9/19/2023
Page No : 1

Groups Printed- BUSES

Start Time	PREINKERT DR From North					From East					PREINKERT DR From South					COLLEGE AVE From West					Int. Total
	Left	Thru	Right	Peds	App. Total	Left	Thru	Right	Peds	App. Total	Left	Thru	Right	Peds	App. Total	Left	Thru	Right	Peds	App. Total	
08:00 AM	0	4	2	0	6	0	0	0	0	0	0	0	0	0	0	0	0	0	0	0	6
08:15 AM	0	5	0	0	5	0	0	0	0	0	0	0	0	0	0	0	0	0	0	0	5
08:30 AM	0	4	0	0	4	0	0	0	0	0	0	0	0	0	0	0	0	0	0	0	4
08:45 AM	0	4	1	0	5	0	0	0	0	0	0	0	0	0	0	0	0	0	0	0	5
Total	0	17	3	0	20	0	0	0	0	0	0	0	0	0	0	0	0	0	0	0	20
09:00 AM	0	5	2	0	7	0	0	0	0	0	0	1	0	0	1	0	0	0	0	0	8
09:15 AM	0	2	1	0	3	0	0	0	0	0	0	0	0	0	0	0	0	0	0	0	3
09:30 AM	0	6	3	0	9	0	0	0	0	0	0	0	0	0	0	0	0	0	0	0	9
09:45 AM	0	5	0	0	5	0	0	0	0	0	0	0	0	0	0	0	0	0	0	0	5
Total	0	18	6	0	24	0	0	0	0	0	0	1	0	0	1	0	0	0	0	0	25
*** BREAK ***																					
03:30 PM	0	6	1	0	7	0	0	0	0	0	1	0	0	0	1	0	0	0	0	0	8
03:45 PM	0	5	1	0	6	0	0	0	0	0	0	0	0	0	0	0	0	0	0	0	6
Total	0	11	2	0	13	0	0	0	0	0	1	0	0	0	1	0	0	0	0	0	14
04:00 PM	0	5	0	0	5	0	0	0	0	0	0	0	0	0	0	0	0	0	0	0	5
04:15 PM	0	5	1	0	6	0	0	0	0	0	0	0	0	0	0	0	0	0	0	0	6
04:30 PM	0	4	1	0	5	0	0	0	0	0	0	0	0	0	0	0	0	0	0	0	5
04:45 PM	0	3	0	0	3	0	0	0	0	0	0	0	0	0	0	0	0	0	0	0	3
Total	0	17	2	0	19	0	0	0	0	0	0	0	0	0	0	0	0	0	0	0	19
05:00 PM	0	4	0	0	4	0	0	0	0	0	0	0	0	0	0	0	0	0	0	0	4
05:15 PM	0	4	3	0	7	0	0	0	0	0	0	0	0	0	0	0	0	0	0	0	7
Grand Total	0	71	16	0	87	0	0	0	0	0	1	1	0	0	2	0	0	0	0	0	89
Apprch %	0	81.6	18.4	0		0	0	0	0		50	50	0	0		0	0	0	0		
Total %	0	79.8	18	0	97.8	0	0	0	0	0	1.1	1.1	0	0	2.2	0	0	0	0	0	

MEAD & HUNT

7055 Samuel Morse Dr. Ste. 100
Columbia, Maryland 21046

443-741-3500

File Name : preinkert at campus dr

Site Code : 00000000

Start Date : 9/19/2023

Page No : 2

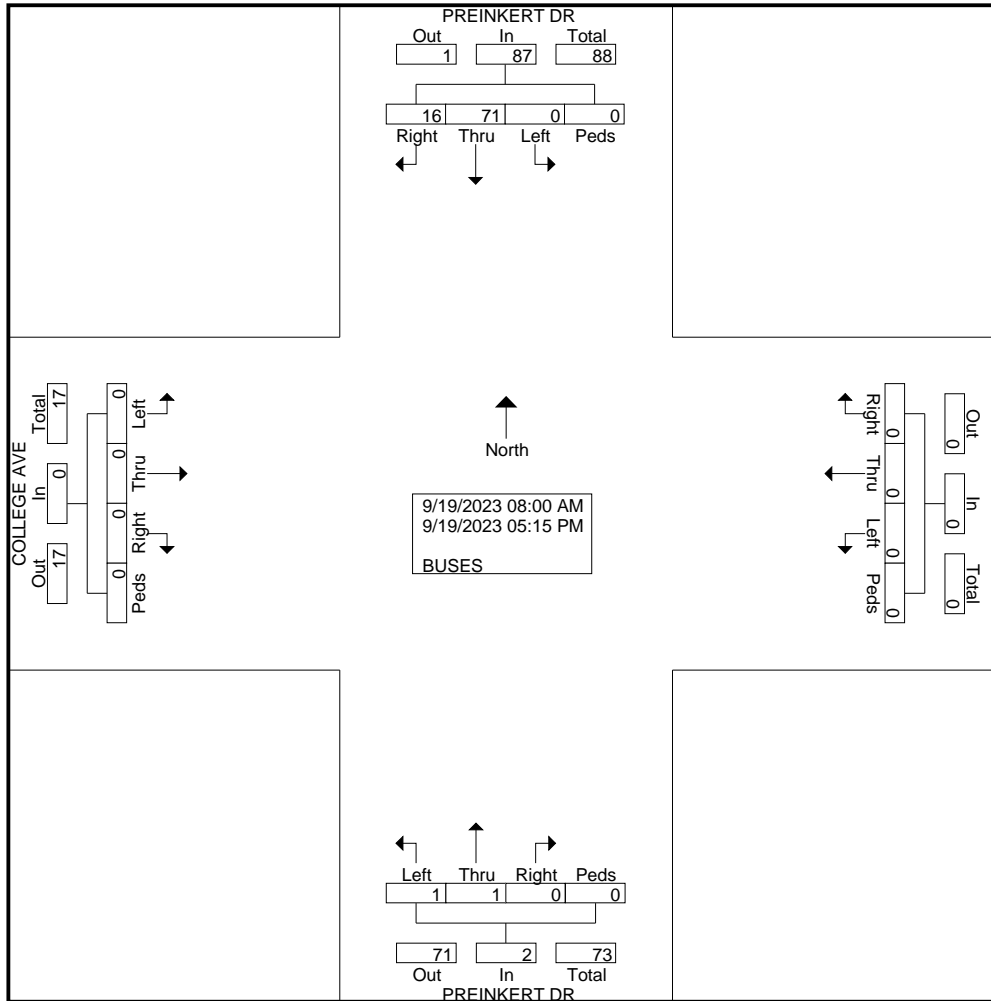

MEAD & HUNT

7055 Samuel Morse Dr. Ste. 100
Columbia, Maryland 21046
443-741-3500

File Name : preinkert at campus dr
Site Code : 00000000
Start Date : 9/19/2023
Page No : 3

Start Time	PREINKERT DR From North					From East					PREINKERT DR From South					COLLEGE AVE From West					Int. Total
	Left	Thru	Right	Peds	App. Total	Left	Thru	Right	Peds	App. Total	Left	Thru	Right	Peds	App. Total	Left	Thru	Right	Peds	App. Total	
Peak Hour Analysis From 08:00 AM to 12:45 PM - Peak 1 of 1																					
Peak Hour for Entire Intersection Begins at 08:45 AM																					
08:45 AM	0	4	1	0	5	0	0	0	0	0	0	0	0	0	0	0	0	0	0	0	5
09:00 AM	0	5	2	0	7	0	0	0	0	0	0	1	0	0	1	0	0	0	0	0	8
09:15 AM	0	2	1	0	3	0	0	0	0	0	0	0	0	0	0	0	0	0	0	0	3
09:30 AM	0	6	3	0	9	0	0	0	0	0	0	0	0	0	0	0	0	0	0	0	9
Total Volume	0	17	7	0	24	0	0	0	0	0	0	1	0	0	1	0	0	0	0	0	25
% App. Total	0	70.8	29.2	0		0	0	0	0		0	100	0	0		0	0	0	0		
PHF	.000	.708	.583	.000	.667	.000	.000	.000	.000	.000	.000	.250	.000	.000	.250	.000	.000	.000	.000	.000	.694

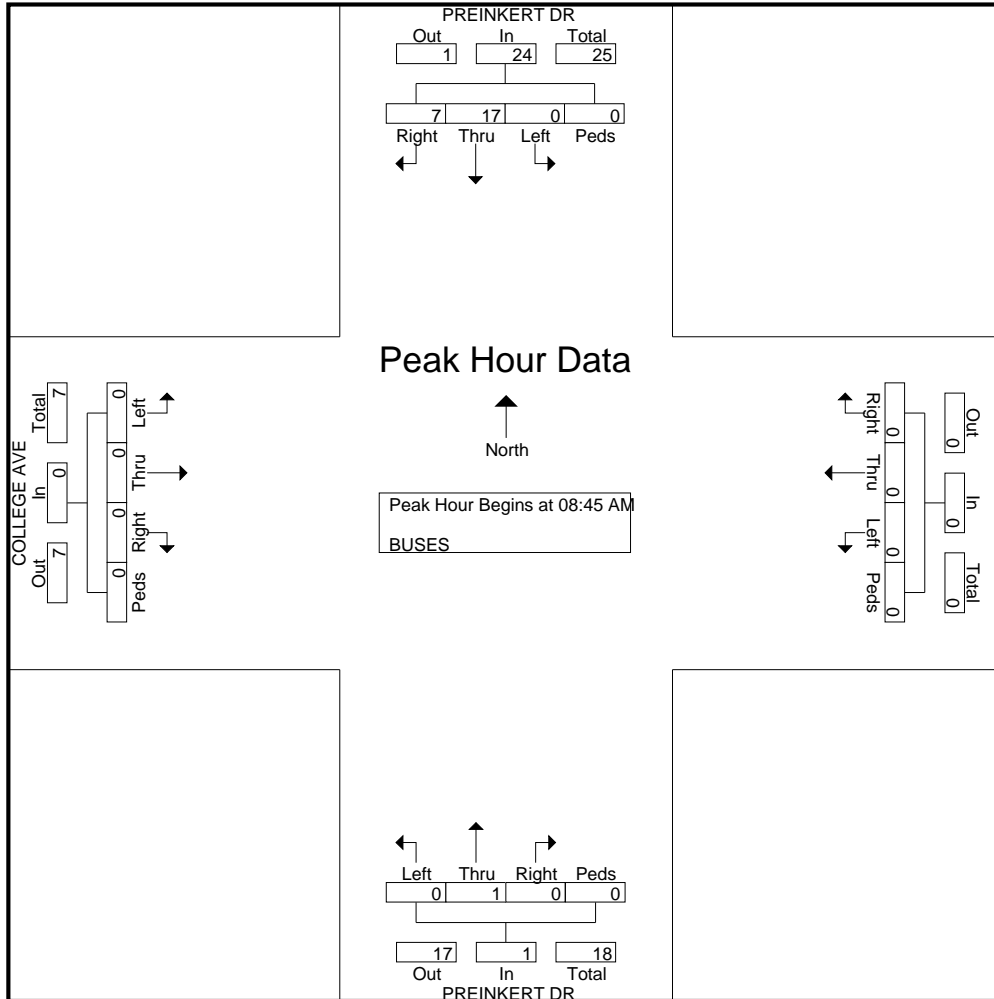

MEAD & HUNT

7055 Samuel Morse Dr. Ste. 100
Columbia, Maryland 21046
443-741-3500

File Name : preinkert at campus dr
Site Code : 00000000
Start Date : 9/19/2023
Page No : 4

Start Time	PREINKERT DR From North					From East					PREINKERT DR From South					COLLEGE AVE From West					Int. Total
	Left	Thru	Right	Peds	App. Total	Left	Thru	Right	Peds	App. Total	Left	Thru	Right	Peds	App. Total	Left	Thru	Right	Peds	App. Total	
Peak Hour Analysis From 01:00 PM to 05:15 PM - Peak 1 of 1																					
Peak Hour for Entire Intersection Begins at 03:30 PM																					
03:30 PM	0	6	1	0	7	0	0	0	0	0	1	0	0	0	1	0	0	0	0	0	8
03:45 PM	0	5	1	0	6	0	0	0	0	0	0	0	0	0	0	0	0	0	0	0	6
04:00 PM	0	5	0	0	5	0	0	0	0	0	0	0	0	0	0	0	0	0	0	0	5
04:15 PM	0	5	1	0	6	0	0	0	0	0	0	0	0	0	0	0	0	0	0	0	6
Total Volume	0	21	3	0	24	0	0	0	0	0	1	0	0	0	1	0	0	0	0	0	25
% App. Total	0	87.5	12.5	0		0	0	0	0	0	100	0	0	0		0	0	0	0		
PHF	.000	.875	.750	.000	.857	.000	.000	.000	.000	.000	.250	.000	.000	.000	.250	.000	.000	.000	.000	.000	.781

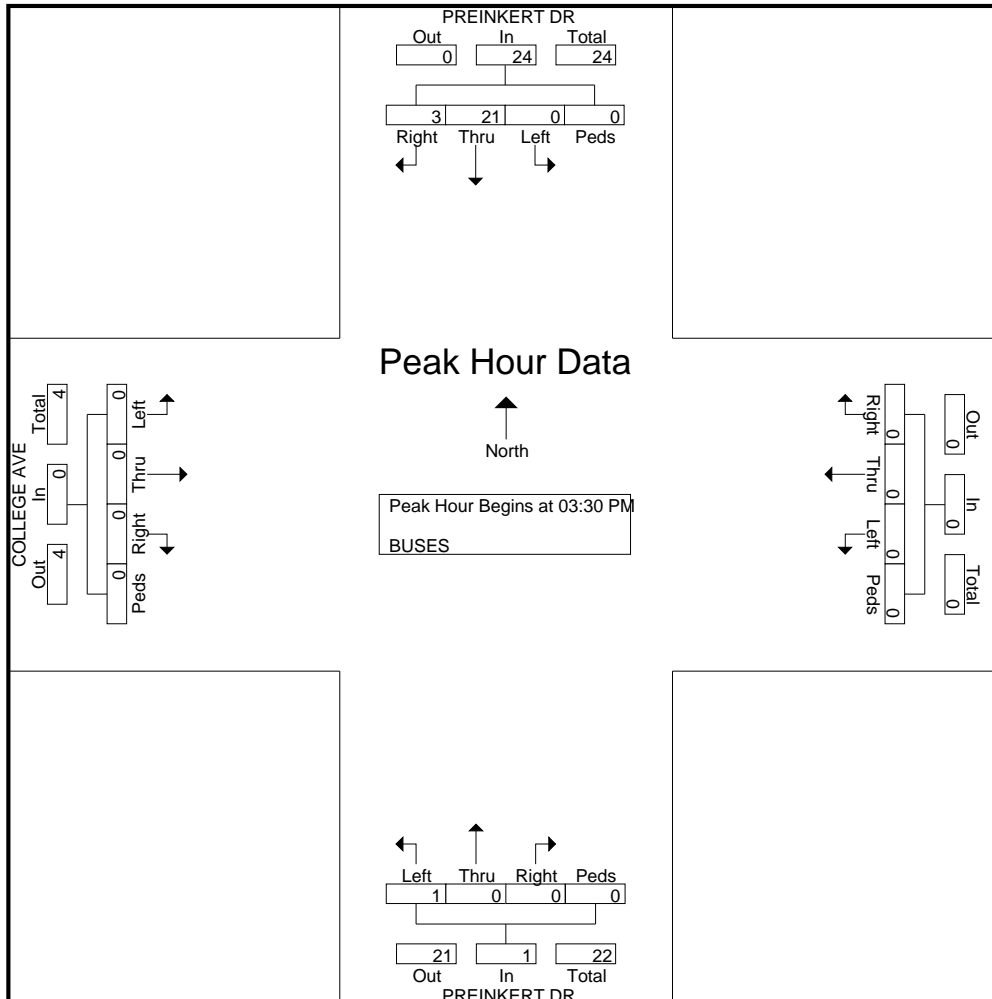

MEAD & HUNT

7055 Samuel Morse Dr. Ste. 100
Columbia, Maryland 21046

443-741-3500

Weather:
Counted By:
Town:
Country

File Name : regents dr at baltimore ave
Site Code : 00000000
Start Date : 9/19/2023
Page No : 1

Groups Printed- VEHS&PEDS

Start Time	BALTIMORE AVE From North					COLLEGE AVE From East					BALTIMORE AVE From South					REGENTS DR From West					Int. Total
	Left	Thru	Right	Peds	App. Total	Left	Thru	Right	Peds	App. Total	Left	Thru	Right	Peds	App. Total	Left	Thru	Right	Peds	App. Total	
08:00 AM	18	166	6	6	196	2	4	9	6	21	18	108	4	8	138	3	1	3	6	13	368
08:15 AM	22	186	5	14	227	2	0	13	3	18	16	121	5	8	150	4	0	6	8	18	413
08:30 AM	24	160	6	39	229	6	1	14	13	34	16	126	1	14	157	4	4	5	13	26	446
08:45 AM	22	132	3	35	192	7	5	20	4	36	23	112	7	6	148	6	0	3	13	22	398
Total	86	644	20	94	844	17	10	56	26	109	73	467	17	36	593	17	5	17	40	79	1625
09:00 AM	15	143	14	170	342	7	9	11	8	35	14	122	5	14	155	6	9	14	20	49	581
09:15 AM	17	186	13	207	423	3	17	9	12	41	24	99	3	31	157	7	4	11	40	62	683
09:30 AM	16	148	6	37	207	3	4	15	9	31	17	106	7	14	144	3	5	7	16	31	413
09:45 AM	20	121	4	31	176	1	4	10	7	22	12	114	7	10	143	4	5	8	16	33	374
Total	68	598	37	445	1148	14	34	45	36	129	67	441	22	69	599	20	23	40	92	175	2051
*** BREAK ***																					
03:30 PM	22	148	5	69	244	7	5	19	19	50	10	179	4	38	231	6	12	20	46	84	609
03:45 PM	17	144	2	52	215	7	8	15	17	47	10	168	7	19	204	8	8	14	28	58	524
Total	39	292	7	121	459	14	13	34	36	97	20	347	11	57	435	14	20	34	74	142	1133
04:00 PM	17	184	2	23	226	5	8	21	13	47	18	154	7	14	193	7	0	15	21	43	509
04:15 PM	17	139	1	19	176	9	4	21	14	48	15	135	17	10	177	5	3	15	24	47	448
04:30 PM	11	135	4	41	191	7	11	26	10	54	19	171	7	15	212	6	1	20	28	55	512
04:45 PM	21	160	3	108	292	6	6	26	10	48	9	178	11	20	218	4	3	21	33	61	619
Total	66	618	10	191	885	27	29	94	47	197	61	638	42	59	800	22	7	71	106	206	2088
05:00 PM	17	158	1	79	255	4	2	19	32	57	8	202	10	26	246	4	8	22	52	86	644
05:15 PM	24	164	1	42	231	5	9	26	11	51	12	184	4	21	221	11	13	29	40	93	596
Grand Total	300	2474	76	972	3822	81	97	274	188	640	241	2279	106	268	2894	88	76	213	404	781	8137
Apprch %	7.8	64.7	2	25.4		12.7	15.2	42.8	29.4		8.3	78.7	3.7	9.3		11.3	9.7	27.3	51.7		
Total %	3.7	30.4	0.9	11.9	47	1	1.2	3.4	2.3	7.9	3	28	1.3	3.3	35.6	1.1	0.9	2.6	5	9.6	

MEAD & HUNT

7055 Samuel Morse Dr. Ste. 100
Columbia, Maryland 21046

443-741-3500

File Name : regents dr at baltimore ave

Site Code : 00000000

Start Date : 9/19/2023

Page No : 2

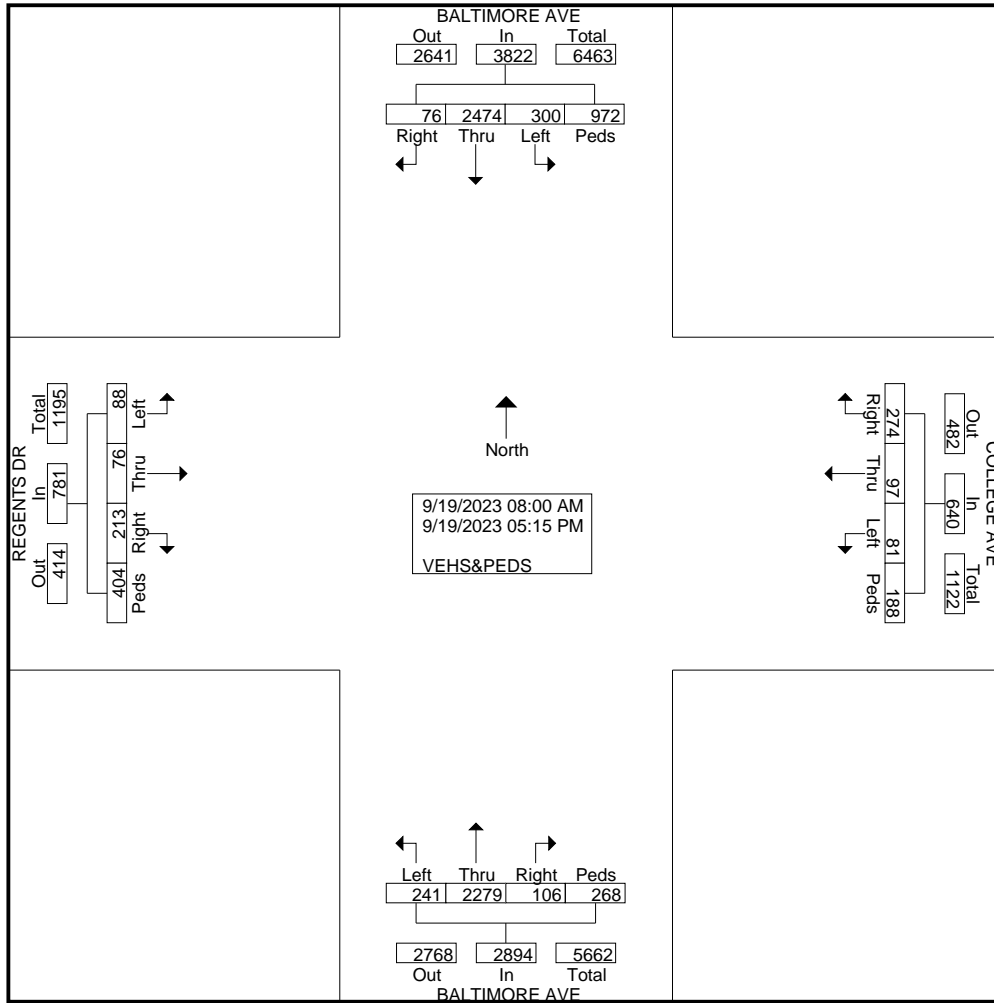

MEAD & HUNT

7055 Samuel Morse Dr. Ste. 100
Columbia, Maryland 21046
443-741-3500

File Name : regents dr at baltimore ave
Site Code : 00000000
Start Date : 9/19/2023
Page No : 3

Start Time	BALTIMORE AVE From North					COLLEGE AVE From East					BALTIMORE AVE From South					REGENTS DR From West					Int. Total
	Left	Thru	Right	Peds	App. Total	Left	Thru	Right	Peds	App. Total	Left	Thru	Right	Peds	App. Total	Left	Thru	Right	Peds	App. Total	
Peak Hour Analysis From 08:00 AM to 12:45 PM - Peak 1 of 1																					
Peak Hour for Entire Intersection Begins at 08:30 AM																					
08:30 AM	24	160	6	39	229	6	1	14	13	34	16	126	1	14	157	4	4	5	13	26	446
08:45 AM	22	132	3	35	192	7	5	20	4	36	23	112	7	6	148	6	0	3	13	22	398
09:00 AM	15	143	14	170	342	7	9	11	8	35	14	122	5	14	155	6	9	14	20	49	581
09:15 AM	17	186	13	207	423	3	17	9	12	41	24	99	3	31	157	7	4	11	40	62	683
Total Volume	78	621	36	451	1186	23	32	54	37	146	77	459	16	65	617	23	17	33	86	159	2108
% App. Total	6.6	52.4	3	38		15.8	21.9	37	25.3		12.5	74.4	2.6	10.5		14.5	10.7	20.8	54.1		
PHF	.813	.835	.643	.545	.701	.821	.471	.675	.712	.890	.802	.911	.571	.524	.982	.821	.472	.589	.538	.641	.772

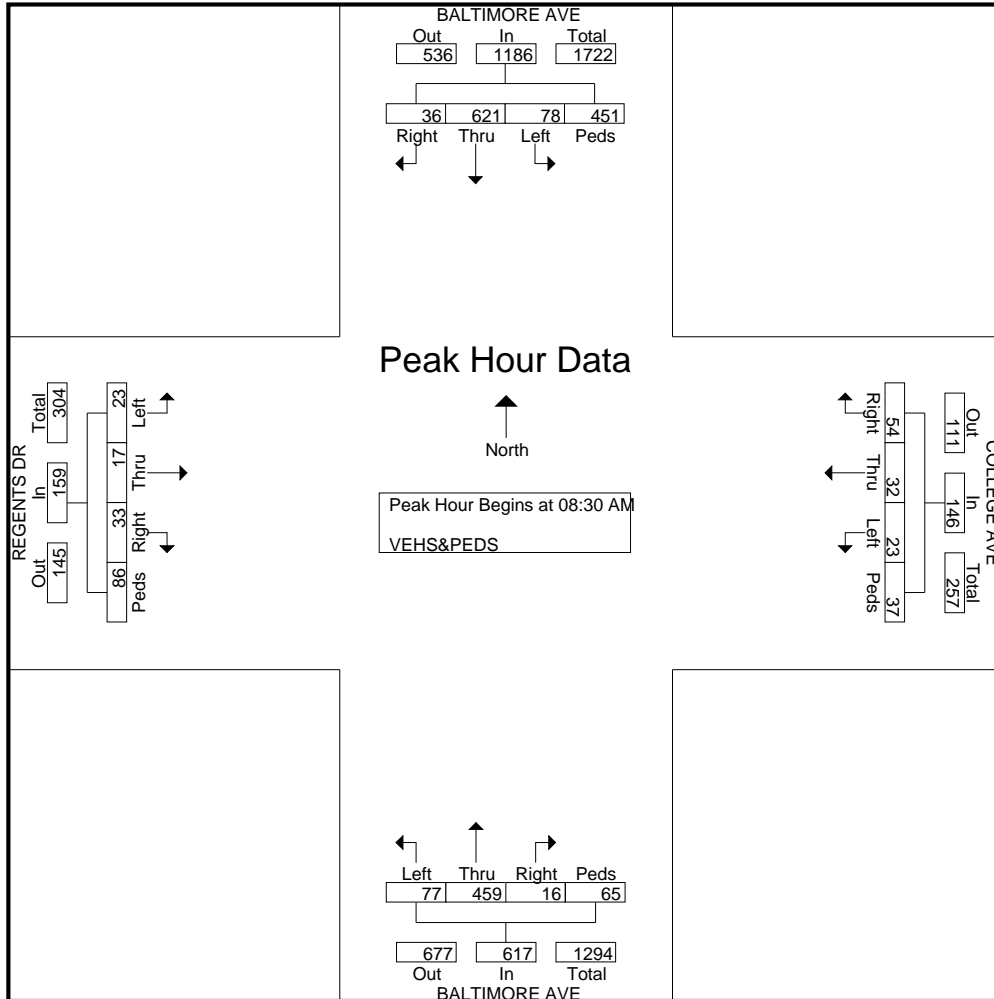

MEAD & HUNT

7055 Samuel Morse Dr. Ste. 100
Columbia, Maryland 21046
443-741-3500

File Name : regents dr at baltimore ave
Site Code : 00000000
Start Date : 9/19/2023
Page No : 4

Start Time	BALTIMORE AVE From North					COLLEGE AVE From East					BALTIMORE AVE From South					REGENTS DR From West					Int. Total
	Left	Thru	Right	Peds	App. Total	Left	Thru	Right	Peds	App. Total	Left	Thru	Right	Peds	App. Total	Left	Thru	Right	Peds	App. Total	

Peak Hour Analysis From 01:00 PM to 05:15 PM - Peak 1 of 1

Peak Hour for Entire Intersection Begins at 04:30 PM

04:30 PM	11	135	4	41	191	7	11	26	10	54	19	171	7	15	212	6	1	20	28	55	512
04:45 PM	21	160	3	108	292	6	6	26	10	48	9	178	11	20	218	4	3	21	33	61	619
05:00 PM	17	158	1	79	255	4	2	19	32	57	8	202	10	26	246	4	8	22	52	86	644
05:15 PM	24	164	1	42	231	5	9	26	11	51	12	184	4	21	221	11	13	29	40	93	596
Total Volume	73	617	9	270	969	22	28	97	63	210	48	735	32	82	897	25	25	92	153	295	2371
% App. Total	7.5	63.7	0.9	27.9		10.5	13.3	46.2	30		5.4	81.9	3.6	9.1		8.5	8.5	31.2	51.9		
PHF	.760	.941	.563	.625	.830	.786	.636	.933	.492	.921	.632	.910	.727	.788	.912	.568	.481	.793	.736	.793	.920

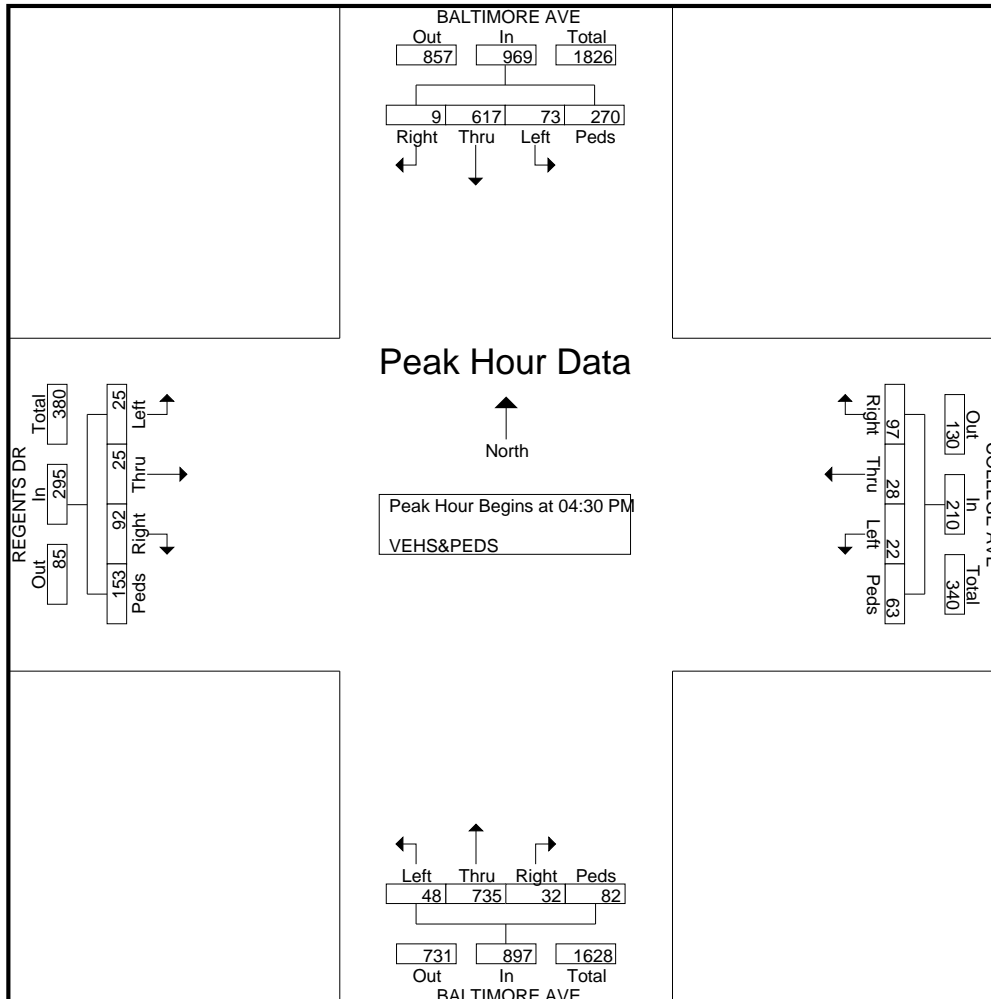

MEAD & HUNT

7055 Samuel Morse Dr. Ste. 100
Columbia, Maryland 21046
443-741-3500

Weather:
Counted By:
Town:
Country

File Name : regents dr at baltimore ave
Site Code : 00000000
Start Date : 9/19/2023
Page No : 1

Groups Printed- BICYCLES

Start Time	BALTIMORE AVE From North					COLLEGE AVE From East					BALTIMORE AVE From South					REGENTS DR From West					Int. Total
	Left	Thru	Right	Peds	App. Total	Left	Thru	Right	Peds	App. Total	Left	Thru	Right	Peds	App. Total	Left	Thru	Right	Peds	App. Total	
08:00 AM	0	1	0	0	1	0	1	0	0	1	0	0	0	0	0	0	0	0	1	1	3
08:15 AM	0	0	0	3	3	0	3	0	1	4	0	1	0	0	1	0	0	0	1	1	9
08:30 AM	0	0	0	4	4	0	4	0	3	7	0	0	0	1	1	0	0	0	6	6	18
08:45 AM	0	0	0	4	4	0	4	0	1	5	0	1	0	0	1	0	0	0	5	5	15
Total	0	1	0	11	12	0	12	0	5	17	0	2	0	1	3	0	0	0	13	13	45
09:00 AM	0	0	0	2	2	0	4	0	4	8	0	0	0	0	0	0	0	0	2	2	12
09:15 AM	0	0	0	3	3	0	4	0	0	4	0	1	0	1	2	0	0	0	8	8	17
09:30 AM	0	0	0	3	3	0	1	0	0	1	0	1	0	2	3	0	0	0	4	4	11
09:45 AM	0	0	0	2	2	0	2	0	0	2	0	0	0	0	0	0	0	0	1	1	5
Total	0	0	0	10	10	0	11	0	4	15	0	2	0	3	5	0	0	0	15	15	45
*** BREAK ***																					
03:30 PM	0	0	1	0	1	0	0	0	0	0	1	1	0	0	2	0	0	1	6	7	10
03:45 PM	0	0	0	0	0	0	2	0	0	2	0	2	0	1	3	0	0	0	11	11	16
Total	0	0	1	0	1	0	2	0	0	2	1	3	0	1	5	0	0	1	17	18	26
04:00 PM	0	0	0	2	2	0	0	0	0	0	0	0	1	2	3	0	1	0	6	7	12
04:15 PM	0	0	0	3	3	0	1	0	1	2	0	0	0	1	1	0	2	0	6	8	14
04:30 PM	0	0	0	2	2	0	0	0	1	1	0	0	0	0	0	0	4	1	6	11	14
04:45 PM	0	1	0	4	5	0	0	0	2	2	0	0	0	3	3	0	1	0	5	6	16
Total	0	1	0	11	12	0	1	0	4	5	0	0	1	6	7	0	8	1	23	32	56
05:00 PM	0	0	0	4	4	0	0	0	0	0	0	0	0	1	1	0	6	0	4	10	15
05:15 PM	0	0	0	3	3	0	0	0	1	1	0	0	0	1	1	0	2	0	4	6	11
Grand Total	0	2	1	39	42	0	26	0	14	40	1	7	1	13	22	0	16	2	76	94	198
Apprch %	0	4.8	2.4	92.9		0	65	0	35		4.5	31.8	4.5	59.1		0	17	2.1	80.9		
Total %	0	1	0.5	19.7	21.2	0	13.1	0	7.1	20.2	0.5	3.5	0.5	6.6	11.1	0	8.1	1	38.4	47.5	

MEAD & HUNT

7055 Samuel Morse Dr. Ste. 100
 Columbia, Maryland 21046
 443-741-3500

File Name : regents dr at baltimore ave
 Site Code : 00000000
 Start Date : 9/19/2023
 Page No : 2

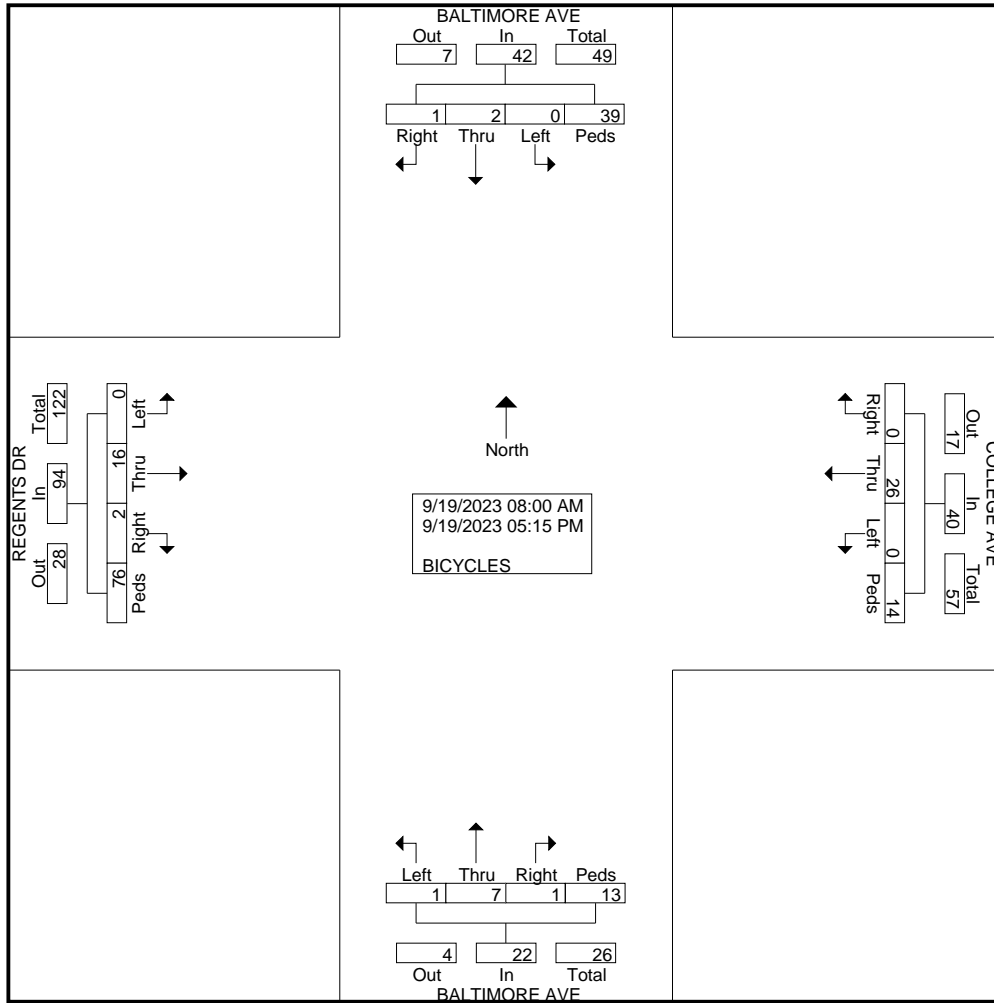

MEAD & HUNT

7055 Samuel Morse Dr. Ste. 100
Columbia, Maryland 21046
443-741-3500

Weather:
Counted By:
Town:
Country

File Name : regents dr at baltimore ave
Site Code : 00000000
Start Date : 9/19/2023
Page No : 1

Groups Printed- SCOOTERS

Start Time	BALTIMORE AVE From North					COLLEGE AVE From East					BALTIMORE AVE From South					REGENTS DR From West					Int. Total
	Left	Thru	Right	Peds	App. Total	Left	Thru	Right	Peds	App. Total	Left	Thru	Right	Peds	App. Total	Left	Thru	Right	Peds	App. Total	
*** BREAK ***																					
08:45 AM	0	0	0	0	0	0	2	0	0	2	0	0	0	0	0	1	0	0	0	1	3
Total	0	0	0	0	0	0	2	0	0	2	0	0	0	0	0	1	0	0	0	1	3
09:00 AM	0	0	0	0	0	0	1	0	0	1	0	0	0	0	0	0	0	0	0	0	1
09:15 AM	0	0	0	0	0	0	6	0	0	6	0	0	0	0	0	0	0	0	0	0	6
09:30 AM	0	0	0	0	0	0	1	0	0	1	0	0	0	0	0	0	0	0	0	0	1
*** BREAK ***																					
Total	0	0	0	0	0	0	8	0	0	8	0	0	0	0	0	0	0	0	0	0	8
*** BREAK ***																					
03:30 PM	0	1	0	0	1	0	0	0	0	0	0	0	0	0	0	0	2	2	0	4	5
03:45 PM	0	0	0	0	0	0	0	0	0	0	2	0	0	0	2	0	1	0	0	1	3
Total	0	1	0	0	1	0	0	0	0	0	2	0	0	0	2	0	3	2	0	5	8
04:00 PM	0	0	0	0	0	0	0	0	0	0	0	0	0	0	0	0	0	1	0	1	1
04:15 PM	0	0	0	0	0	1	3	0	0	4	0	0	0	0	0	0	0	1	0	1	5
04:30 PM	0	0	0	0	0	0	0	0	0	0	0	0	0	0	0	0	0	1	0	1	1
04:45 PM	0	0	0	0	0	0	0	0	0	0	0	0	0	0	0	0	1	0	0	1	1
Total	0	0	0	0	0	1	3	0	0	4	0	0	0	0	0	0	1	3	0	4	8
05:00 PM	0	0	0	0	0	0	0	0	0	0	0	0	0	0	0	0	1	0	0	1	1
05:15 PM	0	0	0	0	0	0	0	0	0	0	0	0	0	0	0	0	0	1	0	1	1
Grand Total	0	1	0	0	1	1	13	0	0	14	2	0	0	0	2	1	5	6	0	12	29
Apprch %	0	100	0	0		7.1	92.9	0	0		100	0	0	0		8.3	41.7	50	0		
Total %	0	3.4	0	0	3.4	3.4	44.8	0	0	48.3	6.9	0	0	0	6.9	3.4	17.2	20.7	0	41.4	

MEAD & HUNT

7055 Samuel Morse Dr. Ste. 100
Columbia, Maryland 21046

443-741-3500

File Name : regents dr at baltimore ave

Site Code : 00000000

Start Date : 9/19/2023

Page No : 2

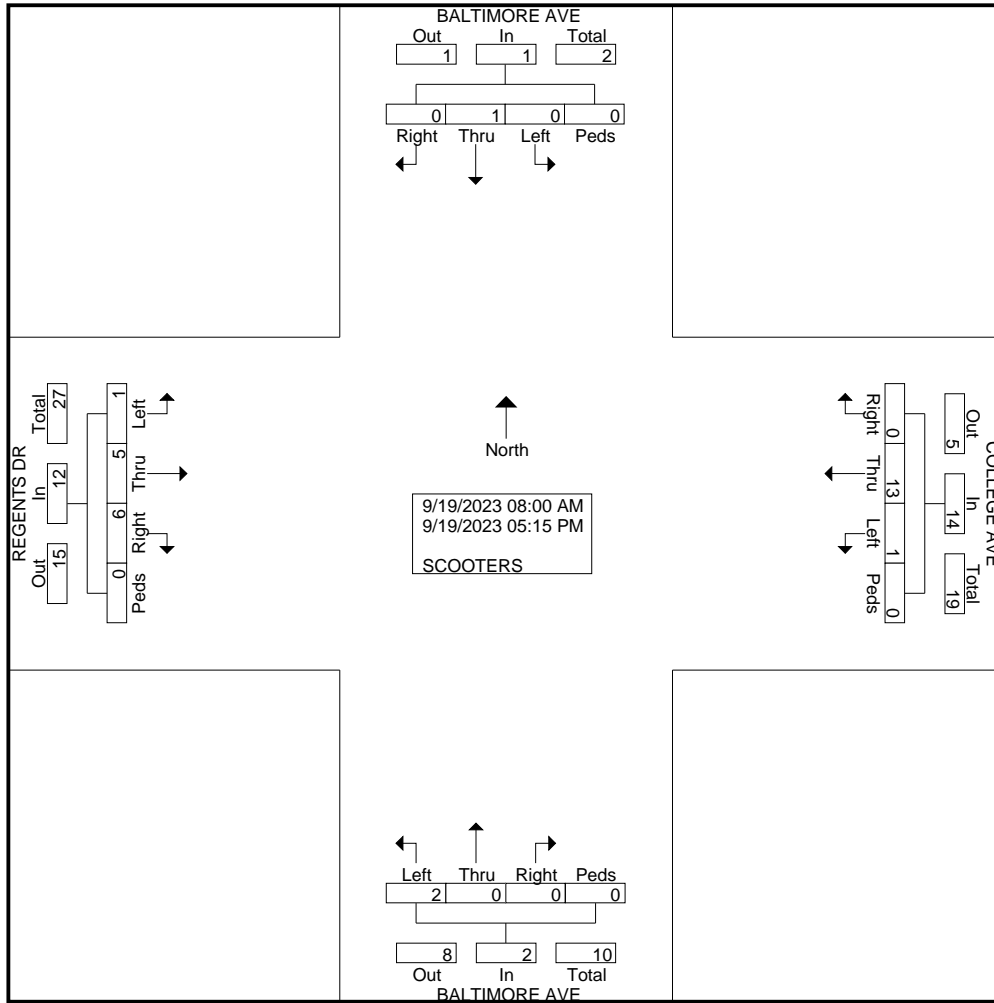

MEAD & HUNT

7055 Samuel Morse Dr. Ste. 100
 Columbia, Maryland 21046
 443-741-3500

Weather:
 Counted By:
 Town:
 Country

File Name : regents dr at baltimore ave
 Site Code : 00000000
 Start Date : 9/19/2023
 Page No : 1

Groups Printed- SKATEBOARDS

Start Time	BALTIMORE AVE From North					COLLEGE AVE From East					BALTIMORE AVE From South					REGENTS DR From West					Int. Total
	Left	Thru	Right	Peds	App. Total	Left	Thru	Right	Peds	App. Total	Left	Thru	Right	Peds	App. Total	Left	Thru	Right	Peds	App. Total	
*** BREAK ***																					
09:15 AM	0	0	0	0	0	0	0	0	0	0	0	0	0	0	0	0	0	0	1	1	1
*** BREAK ***																					
09:45 AM	0	0	0	2	2	0	0	0	0	0	0	0	0	0	0	0	0	0	0	0	2
Total	0	0	0	2	2	0	0	0	0	0	0	0	0	0	0	0	0	0	1	1	3
*** BREAK ***																					
04:30 PM	0	0	0	0	0	0	0	0	1	1	0	0	0	1	1	0	0	0	0	0	2
*** BREAK ***																					
Total	0	0	0	0	0	0	0	0	1	1	0	0	0	1	1	0	0	0	0	0	2
*** BREAK ***																					
Grand Total	0	0	0	2	2	0	0	0	1	1	0	0	0	1	1	0	0	0	1	1	5
Apprch %	0	0	0	100		0	0	0	100		0	0	0	100		0	0	0	100		
Total %	0	0	0	40	40	0	0	0	20	20	0	0	0	20	20	0	0	0	20	20	

MEAD & HUNT

7055 Samuel Morse Dr. Ste. 100
Columbia, Maryland 21046

443-741-3500

File Name : regents dr at baltimore ave

Site Code : 00000000

Start Date : 9/19/2023

Page No : 2

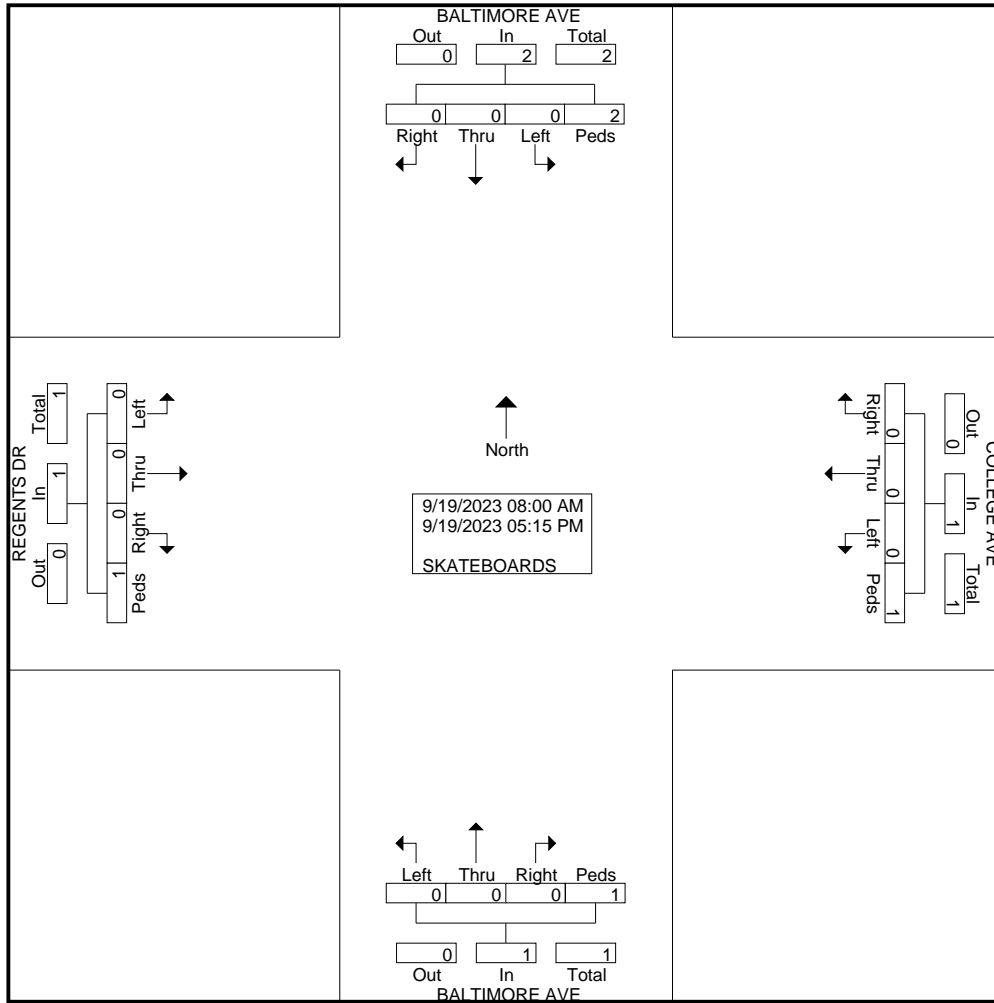

MEAD & HUNT

7055 Samuel Morse Dr. Ste. 100
Columbia, Maryland 21046
443-741-3500

Weather:
Counted By:
Town:
Country

File Name : regents dr at baltimore ave
Site Code : 00000000
Start Date : 9/19/2023
Page No : 1

Groups Printed- BUSES

Start Time	BALTIMORE AVE From North					COLLEGE AVE From East					BALTIMORE AVE From South					REGENTS DR From West					Int. Total
	Left	Thru	Right	Peds	App. Total	Left	Thru	Right	Peds	App. Total	Left	Thru	Right	Peds	App. Total	Left	Thru	Right	Peds	App. Total	
08:00 AM	0	5	0	0	5	0	0	0	0	0	3	5	0	0	8	1	0	0	0	1	14
08:15 AM	0	4	0	0	4	0	0	0	0	0	1	7	0	0	8	1	0	0	0	1	13
08:30 AM	0	1	0	0	1	0	0	0	0	0	0	6	0	0	6	1	0	0	0	1	8
08:45 AM	0	6	0	0	6	0	0	0	0	0	3	7	0	0	10	1	0	0	0	1	17
Total	0	16	0	0	16	0	0	0	0	0	7	25	0	0	32	4	0	0	0	4	52
09:00 AM	0	2	0	0	2	0	0	2	0	2	1	7	0	0	8	1	0	0	0	1	13
09:15 AM	0	4	0	0	4	0	0	0	0	0	0	4	0	0	4	1	0	0	0	1	9
09:30 AM	0	3	0	0	3	0	0	0	0	0	2	5	0	0	7	1	0	0	0	1	11
09:45 AM	0	3	0	0	3	0	0	0	0	0	2	5	0	0	7	1	0	0	0	1	11
Total	0	12	0	0	12	0	0	2	0	2	5	21	0	0	26	4	0	0	0	4	44
*** BREAK ***																					
03:30 PM	1	2	0	0	3	0	0	1	0	1	1	5	0	0	6	1	0	0	0	1	11
03:45 PM	1	2	0	0	3	0	0	1	0	1	3	5	0	0	8	1	0	0	0	1	13
Total	2	4	0	0	6	0	0	2	0	2	4	10	0	0	14	2	0	0	0	2	24
04:00 PM	0	2	0	0	2	0	0	0	0	0	2	6	0	0	8	1	0	0	0	1	11
04:15 PM	0	2	0	0	2	0	0	0	0	0	0	5	0	0	5	1	0	0	0	1	8
04:30 PM	1	0	0	0	1	0	0	0	0	0	1	5	0	0	6	0	0	0	0	0	7
04:45 PM	0	3	0	0	3	0	0	0	0	0	1	5	0	0	6	1	0	0	0	1	10
Total	1	7	0	0	8	0	0	0	0	0	4	21	0	0	25	3	0	0	0	3	36
05:00 PM	0	1	0	0	1	0	0	0	0	0	0	5	0	0	5	1	0	0	0	1	7
05:15 PM	0	2	0	0	2	0	0	0	0	0	3	5	0	0	8	1	0	0	0	1	11
Grand Total	3	42	0	0	45	0	0	4	0	4	23	87	0	0	110	15	0	0	0	15	174
Apprch %	6.7	93.3	0	0		0	0	100	0		20.9	79.1	0	0		100	0	0	0		
Total %	1.7	24.1	0	0	25.9	0	0	2.3	0	2.3	13.2	50	0	0	63.2	8.6	0	0	0	8.6	

MEAD & HUNT

7055 Samuel Morse Dr. Ste. 100
 Columbia, Maryland 21046
 443-741-3500

File Name : regents dr at baltimore ave
 Site Code : 00000000
 Start Date : 9/19/2023
 Page No : 2

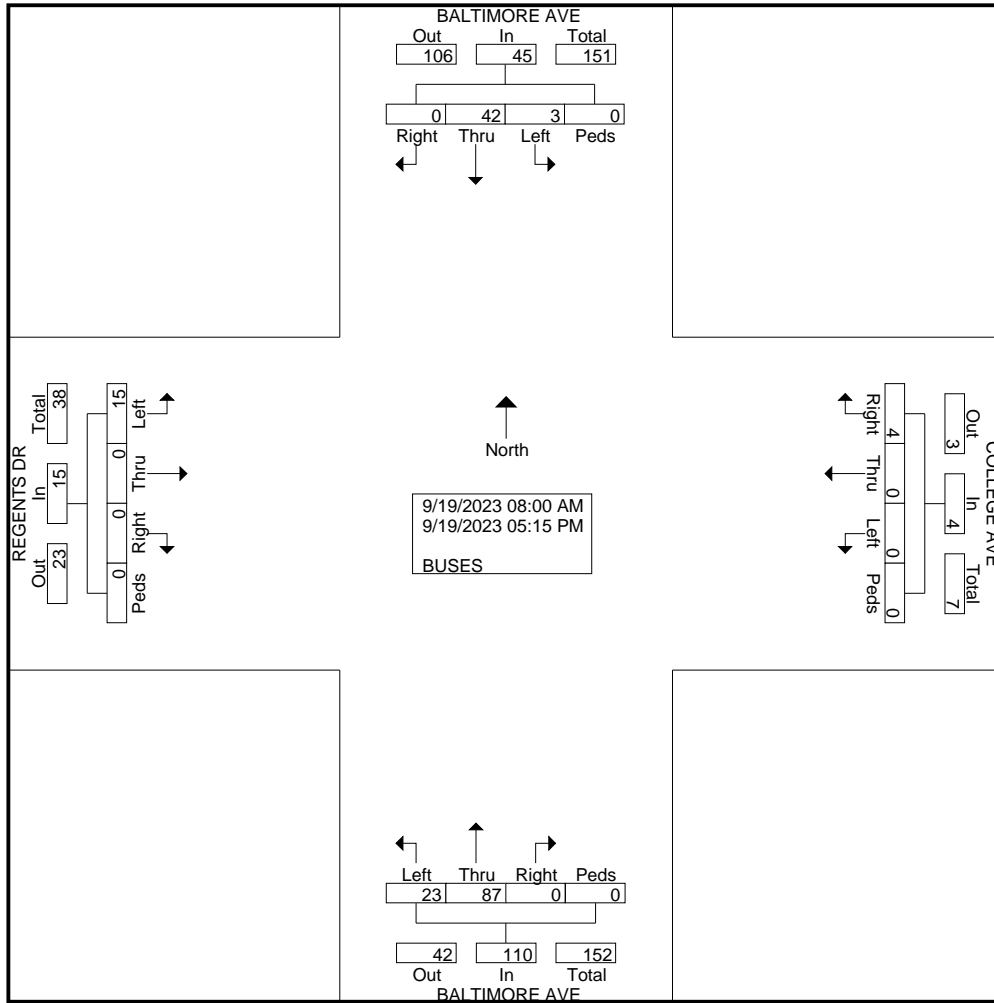

MEAD & HUNT

7055 Samuel Morse Dr. Ste. 100
Columbia, Maryland 21046
443-741-3500

File Name : regents dr at baltimore ave
Site Code : 00000000
Start Date : 9/19/2023
Page No : 3

Start Time	BALTIMORE AVE From North					COLLEGE AVE From East					BALTIMORE AVE From South					REGENTS DR From West					Int. Total
	Left	Thru	Right	Peds	App. Total	Left	Thru	Right	Peds	App. Total	Left	Thru	Right	Peds	App. Total	Left	Thru	Right	Peds	App. Total	
Peak Hour Analysis From 08:00 AM to 12:45 PM - Peak 1 of 1																					
Peak Hour for Entire Intersection Begins at 08:00 AM																					
08:00 AM	0	5	0	0	5	0	0	0	0	0	3	5	0	0	8	1	0	0	0	1	14
08:15 AM	0	4	0	0	4	0	0	0	0	0	1	7	0	0	8	1	0	0	0	1	13
08:30 AM	0	1	0	0	1	0	0	0	0	0	0	6	0	0	6	1	0	0	0	1	8
08:45 AM	0	6	0	0	6	0	0	0	0	0	3	7	0	0	10	1	0	0	0	1	17
Total Volume	0	16	0	0	16	0	0	0	0	0	7	25	0	0	32	4	0	0	0	4	52
% App. Total	0	100	0	0		0	0	0	0		21.9	78.1	0	0		100	0	0	0		
PHF	.000	.667	.000	.000	.667	.000	.000	.000	.000	.000	.583	.893	.000	.000	.800	1.00	.000	.000	.000	1.00	.765

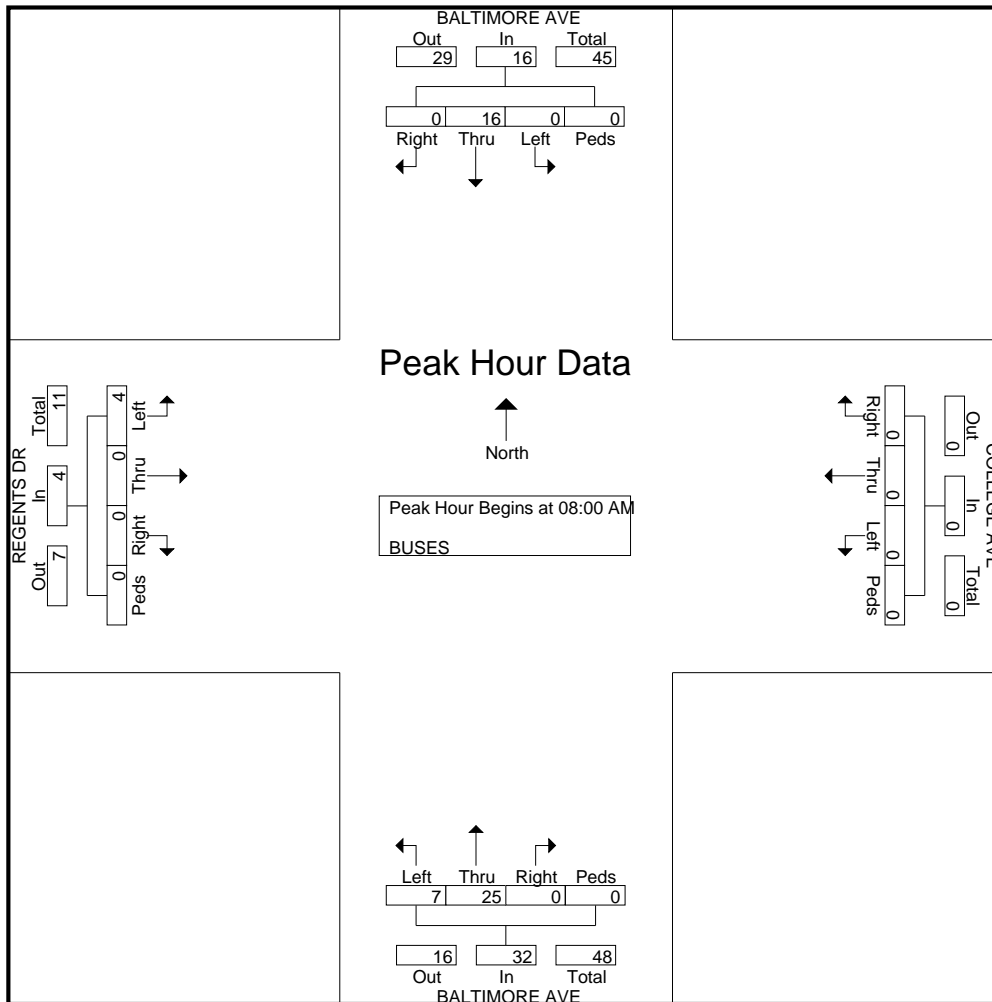

MEAD & HUNT

7055 Samuel Morse Dr. Ste. 100
Columbia, Maryland 21046
443-741-3500

File Name : regents dr at baltimore ave
Site Code : 00000000
Start Date : 9/19/2023
Page No : 4

Start Time	BALTIMORE AVE From North					COLLEGE AVE From East					BALTIMORE AVE From South					REGENTS DR From West					Int. Total
	Left	Thru	Right	Peds	App. Total	Left	Thru	Right	Peds	App. Total	Left	Thru	Right	Peds	App. Total	Left	Thru	Right	Peds	App. Total	
Peak Hour Analysis From 01:00 PM to 05:15 PM - Peak 1 of 1																					
Peak Hour for Entire Intersection Begins at 03:30 PM																					
03:30 PM	1	2	0	0	3	0	0	1	0	1	1	5	0	0	6	1	0	0	0	1	11
03:45 PM	1	2	0	0	3	0	0	1	0	1	3	5	0	0	8	1	0	0	0	1	13
04:00 PM	0	2	0	0	2	0	0	0	0	0	2	6	0	0	8	1	0	0	0	1	11
04:15 PM	0	2	0	0	2	0	0	0	0	0	0	5	0	0	5	1	0	0	0	1	8
Total Volume	2	8	0	0	10	0	0	2	0	2	6	21	0	0	27	4	0	0	0	4	43
% App. Total	20	80	0	0		0	0	100	0		22.2	77.8	0	0		100	0	0	0		
PHF	.500	1.00	.000	.000	.833	.000	.000	.500	.000	.500	.500	.875	.000	.000	.844	1.00	.000	.000	.000	1.00	.827

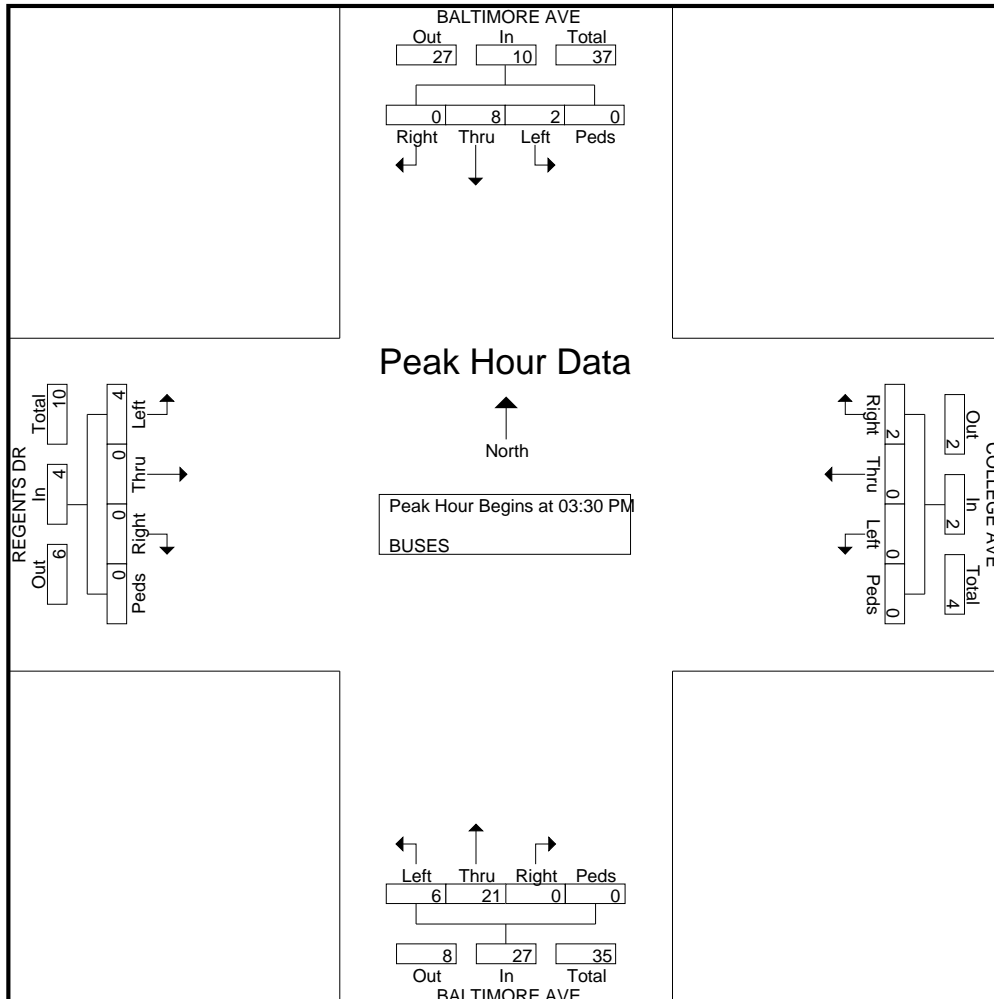

MEAD & HUNT

7055 Samuel Morse Dr. Ste. 100
 Columbia, Maryland 21046
 443-741-3500

Weather:
 Counted By:
 Town:
 Country

File Name : regents dr at baltimore ave
 Site Code : 00000000
 Start Date : 9/19/2023
 Page No : 1

Groups Printed- U TURNS

Start Time	BALTIMORE AVE From North					COLLEGE AVE From East					BALTIMORE AVE From South					REGENTS DR From West					Int. Total
	Left	Thru	Right	Peds	App. Total	Left	Thru	Right	Peds	App. Total	Left	Thru	Right	Peds	App. Total	Left	Thru	Right	Peds	App. Total	
*** BREAK ***																					
08:45 AM	0	0	0	0	0	0	0	0	0	0	1	0	0	0	1	0	0	0	0	0	1
Total	0	0	0	0	0	0	0	0	0	0	1	0	0	0	1	0	0	0	0	0	1
09:00 AM	1	0	0	0	1	0	0	0	0	0	0	0	0	0	0	0	0	0	0	0	1
*** BREAK ***																					
09:45 AM	0	0	0	0	0	1	0	0	0	1	0	0	0	0	0	0	0	0	0	0	1
Total	1	0	0	0	1	1	0	0	0	1	0	0	0	0	0	0	0	0	0	0	2
*** BREAK ***																					
03:30 PM	0	0	0	0	0	0	0	0	0	0	1	0	0	0	1	0	0	0	0	0	1
*** BREAK ***																					
Total	0	0	0	0	0	0	0	0	0	0	1	0	0	0	1	0	0	0	0	0	1
04:00 PM	0	0	0	0	0	0	0	0	0	0	3	0	0	0	3	0	0	0	0	0	3
*** BREAK ***																					
Total	0	0	0	0	0	0	0	0	0	0	3	0	0	0	3	0	0	0	0	0	3
05:00 PM	1	0	0	0	1	0	0	0	0	0	0	0	0	0	0	0	0	0	0	0	1
05:15 PM	0	0	0	0	0	0	0	0	0	0	1	0	0	0	1	0	0	0	0	0	1
Grand Total	2	0	0	0	2	1	0	0	0	1	6	0	0	0	6	0	0	0	0	0	9
Apprch %	100	0	0	0		100	0	0	0		100	0	0	0		0	0	0	0		
Total %	22.2	0	0	0	22.2	11.1	0	0	0	11.1	66.7	0	0	0	66.7	0	0	0	0	0	

MEAD & HUNT

7055 Samuel Morse Dr. Ste. 100
Columbia, Maryland 21046

443-741-3500

File Name : regents dr at baltimore ave

Site Code : 00000000

Start Date : 9/19/2023

Page No : 2

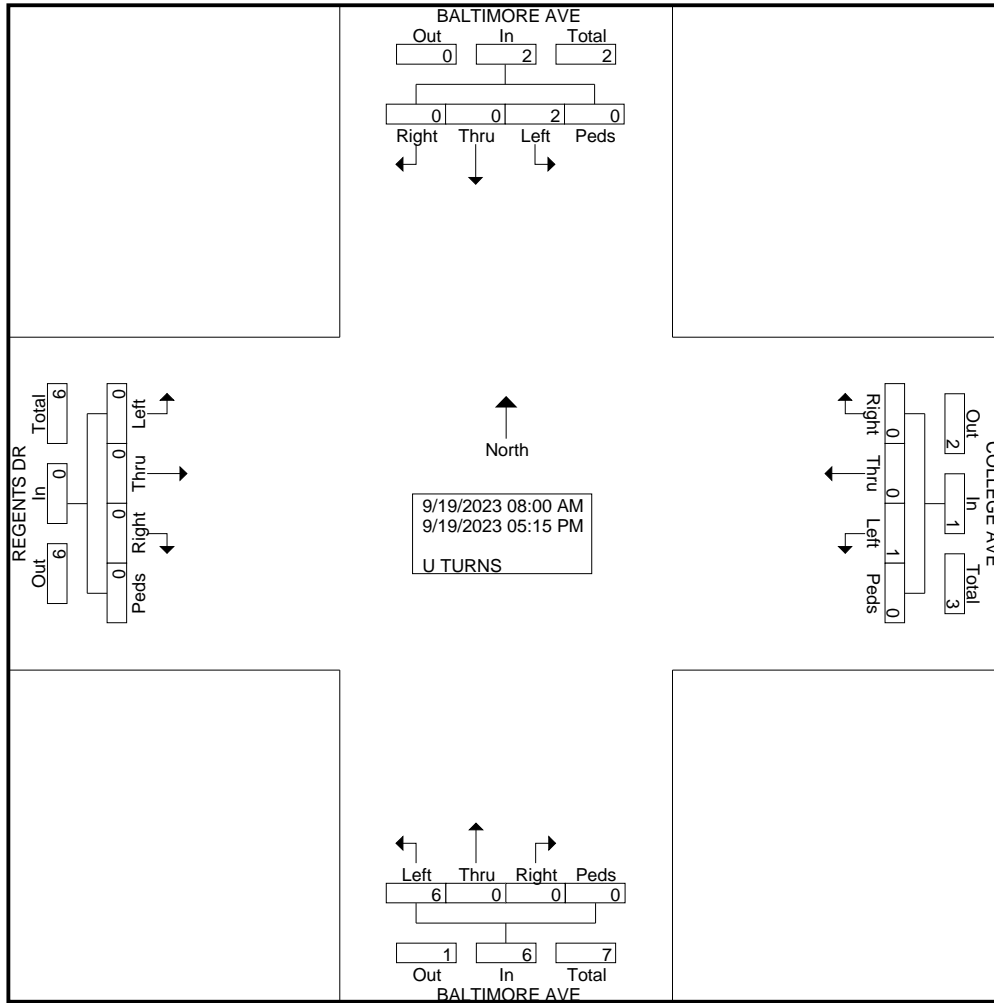

MEAD & HUNT

7055 Samuel Morse Dr. Ste. 100
Columbia, Maryland 21046
443-741-3500

Weather:
Counted By:
Town:
Country

File Name : regents dr at campus dr
Site Code : 00000000
Start Date : 9/19/2023
Page No : 1

Groups Printed- VEHS&PEDS

Start Time	REGENTS DR From North					CAMPUS DR From East					REGENTS DR From South					CAMPUS DR From West					Int. Total
	Left	Thru	Right	Peds	App. Total	Left	Thru	Right	Peds	App. Total	Left	Thru	Right	Peds	App. Total	Left	Thru	Right	Peds	App. Total	
08:00 AM	11	10	9	0	30	13	21	50	1	85	4	17	5	0	26	0	0	0	0	0	141
08:15 AM	16	20	7	0	43	18	11	51	0	80	6	14	2	0	22	0	0	0	0	0	145
08:30 AM	13	17	5	0	35	15	26	66	0	107	3	13	5	0	21	0	0	0	0	0	163
08:45 AM	17	14	6	0	37	16	21	51	0	88	3	22	8	0	33	0	0	0	0	0	158
Total	57	61	27	0	145	62	79	218	1	360	16	66	20	0	102	0	0	0	0	0	607
09:00 AM	13	29	10	0	52	19	18	58	0	95	1	19	6	5	31	0	0	0	0	0	178
09:15 AM	8	17	11	0	36	17	16	25	0	58	5	25	13	0	43	0	0	0	0	0	137
09:30 AM	23	19	5	0	47	10	23	41	0	74	7	20	4	0	31	0	0	0	0	0	152
09:45 AM	17	13	8	0	38	8	21	33	0	62	3	11	5	16	35	0	0	0	0	0	135
Total	61	78	34	0	173	54	78	157	0	289	16	75	28	21	140	0	0	0	0	0	602
Grand Total	118	139	61	0	318	116	157	375	1	649	32	141	48	21	242	0	0	0	0	0	1209
Apprch %	37.1	43.7	19.2	0		17.9	24.2	57.8	0.2		13.2	58.3	19.8	8.7		0	0	0	0	0	
Total %	9.8	11.5	5	0	26.3	9.6	13	31	0.1	53.7	2.6	11.7	4	1.7	20	0	0	0	0	0	

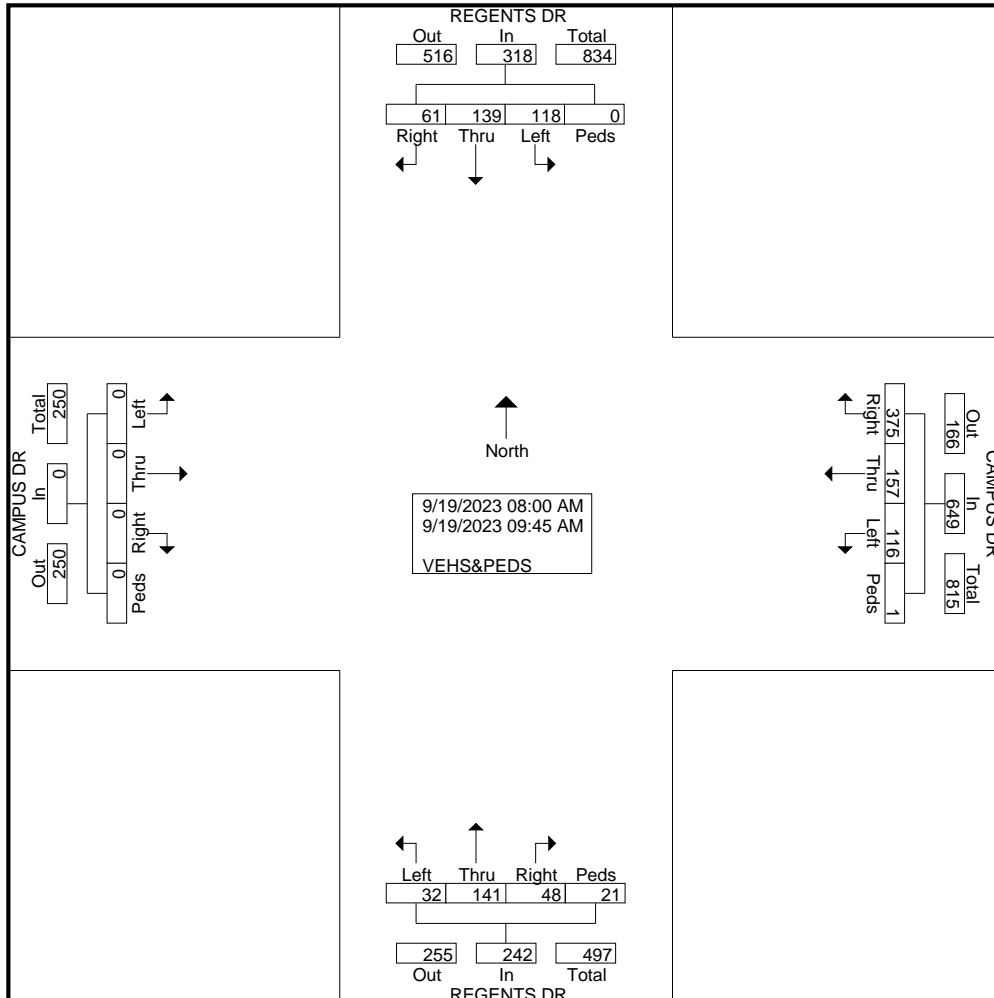

MEAD & HUNT

7055 Samuel Morse Dr. Ste. 100
Columbia, Maryland 21046
443-741-3500

File Name : regents dr at campus dr
Site Code : 00000000
Start Date : 9/19/2023
Page No : 2

Start Time	REGENTS DR From North					CAMPUS DR From East					REGENTS DR From South					CAMPUS DR From West					Int. Total
	Left	Thru	Right	Peds	App. Total	Left	Thru	Right	Peds	App. Total	Left	Thru	Right	Peds	App. Total	Left	Thru	Right	Peds	App. Total	
Peak Hour Analysis From 08:00 AM to 09:45 AM - Peak 1 of 1																					
Peak Hour for Entire Intersection Begins at 08:15 AM																					
08:15 AM	16	20	7	0	43	18	11	51	0	80	6	14	2	0	22	0	0	0	0	0	145
08:30 AM	13	17	5	0	35	15	26	66	0	107	3	13	5	0	21	0	0	0	0	0	163
08:45 AM	17	14	6	0	37	16	21	51	0	88	3	22	8	0	33	0	0	0	0	0	158
09:00 AM	13	29	10	0	52	19	18	58	0	95	1	19	6	5	31	0	0	0	0	0	178
Total Volume	59	80	28	0	167	68	76	226	0	370	13	68	21	5	107	0	0	0	0	0	644
% App. Total	35.3	47.9	16.8	0		18.4	20.5	61.1	0		12.1	63.6	19.6	4.7		0	0	0	0	0	
PHF	.868	.690	.700	.000	.803	.895	.731	.856	.000	.864	.542	.773	.656	.250	.811	.000	.000	.000	.000	.000	.904

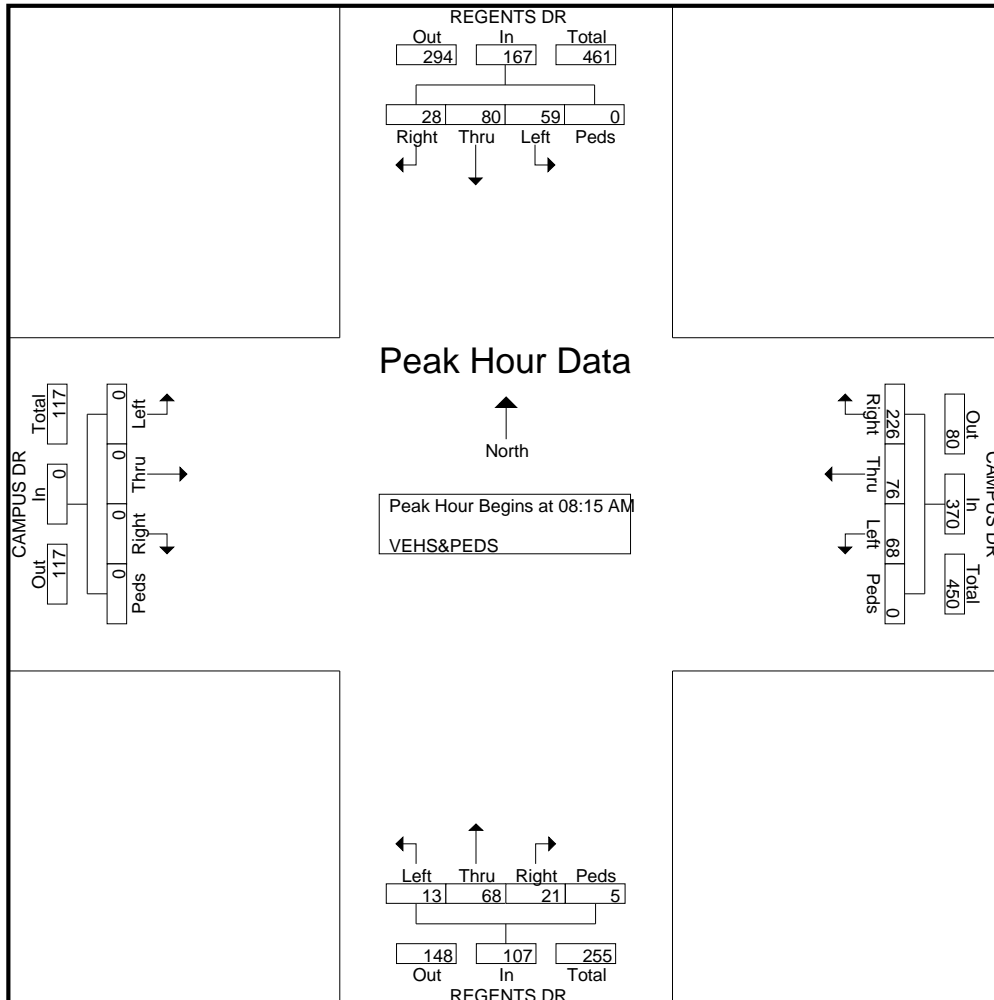

MEAD & HUNT

7055 Samuel Morse Dr. Ste. 100
Columbia, Maryland 21046
443-741-3500

Weather:
Counted By:
Town:
Country

File Name : regents dr at campus dr
Site Code : 00000000
Start Date : 9/19/2023
Page No : 1

Groups Printed- BICYCLES

Start Time	REGENTS DR From North					CAMPUS DR From East					REGENTS DR From South					CAMPUS DR From West					Int. Total
	Left	Thru	Right	Peds	App. Total	Left	Thru	Right	Peds	App. Total	Left	Thru	Right	Peds	App. Total	Left	Thru	Right	Peds	App. Total	
08:00 AM	0	4	1	0	5	0	0	1	0	1	0	5	0	0	5	0	0	0	0	0	11
08:15 AM	1	4	0	0	5	0	2	1	0	3	0	0	0	0	0	0	0	0	0	0	8
08:30 AM	0	4	0	0	4	0	1	0	0	1	0	2	0	0	2	0	0	0	0	0	7
08:45 AM	0	5	0	0	5	0	0	0	0	0	1	6	2	0	9	0	0	1	0	1	15
Total	1	17	1	0	19	0	3	2	0	5	1	13	2	0	16	0	0	1	0	1	41
09:00 AM	1	8	0	0	9	1	1	0	0	2	0	2	3	0	5	0	1	0	0	1	17
09:15 AM	1	12	1	0	14	1	2	0	0	3	0	12	2	0	14	0	0	0	0	0	31
09:30 AM	0	4	1	0	5	2	1	0	0	3	0	6	2	0	8	0	1	0	0	1	17
09:45 AM	0	2	0	0	2	3	0	0	0	3	0	0	0	0	0	0	0	0	0	0	5
Total	2	26	2	0	30	7	4	0	0	11	0	20	7	0	27	0	2	0	0	2	70
Grand Total	3	43	3	0	49	7	7	2	0	16	1	33	9	0	43	0	2	1	0	3	111
Apprch %	6.1	87.8	6.1	0		43.8	43.8	12.5	0		2.3	76.7	20.9	0		0	66.7	33.3	0		
Total %	2.7	38.7	2.7	0	44.1	6.3	6.3	1.8	0	14.4	0.9	29.7	8.1	0	38.7	0	1.8	0.9	0	2.7	

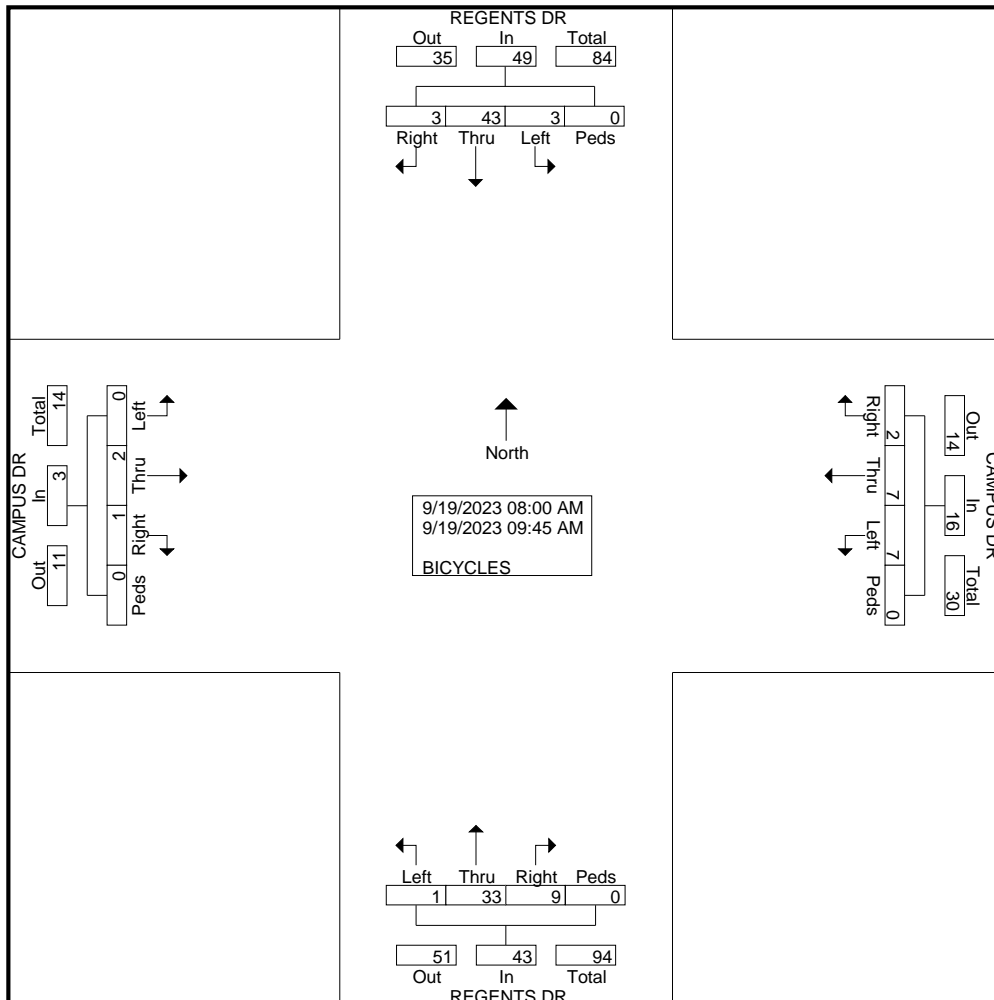

MEAD & HUNT

7055 Samuel Morse Dr. Ste. 100
Columbia, Maryland 21046

443-741-3500

MEAD & HUNT

7055 Samuel Morse Dr. Ste. 100
Columbia, Maryland 21046

443-741-3500

Weather:
Counted By:
Town:
Country

File Name : regents dr at campus dr
Site Code : 00000000
Start Date : 9/19/2023
Page No : 1

Groups Printed- SCOOTERS

Start Time	REGENTS DR From North					CAMPUS DR From East					REGENTS DR From South					CAMPUS DR From West					Int. Total
	Left	Thru	Right	Peds	App. Total	Left	Thru	Right	Peds	App. Total	Left	Thru	Right	Peds	App. Total	Left	Thru	Right	Peds	App. Total	
08:00 AM	0	1	0	0	1	0	1	0	0	1	0	2	0	0	2	0	0	0	0	0	4
08:15 AM	0	0	1	0	1	0	0	0	0	0	0	1	0	0	1	0	0	0	0	0	2
08:30 AM	0	0	0	0	0	0	1	0	0	1	0	0	2	0	2	0	0	0	0	0	3
08:45 AM	1	3	3	0	7	0	1	0	0	1	0	2	5	0	7	0	0	0	0	0	15
Total	1	4	4	0	9	0	3	0	0	3	0	5	7	0	12	0	0	0	0	0	24
09:00 AM	2	1	0	0	3	1	1	0	0	2	0	7	0	0	7	0	0	0	0	0	12
09:15 AM	3	21	4	0	28	3	6	0	0	9	0	17	3	0	20	0	0	0	0	0	57
09:30 AM	0	8	1	0	9	2	2	0	0	4	1	4	0	0	5	0	3	0	0	3	21
09:45 AM	0	7	0	0	7	0	0	0	0	0	0	0	0	0	0	0	0	0	0	0	7
Total	5	37	5	0	47	6	9	0	0	15	1	28	3	0	32	0	3	0	0	3	97
Grand Total	6	41	9	0	56	6	12	0	0	18	1	33	10	0	44	0	3	0	0	3	121
Apprch %	10.7	73.2	16.1	0		33.3	66.7	0	0		2.3	75	22.7	0		0	100	0	0		
Total %	5	33.9	7.4	0	46.3	5	9.9	0	0	14.9	0.8	27.3	8.3	0	36.4	0	2.5	0	0	2.5	

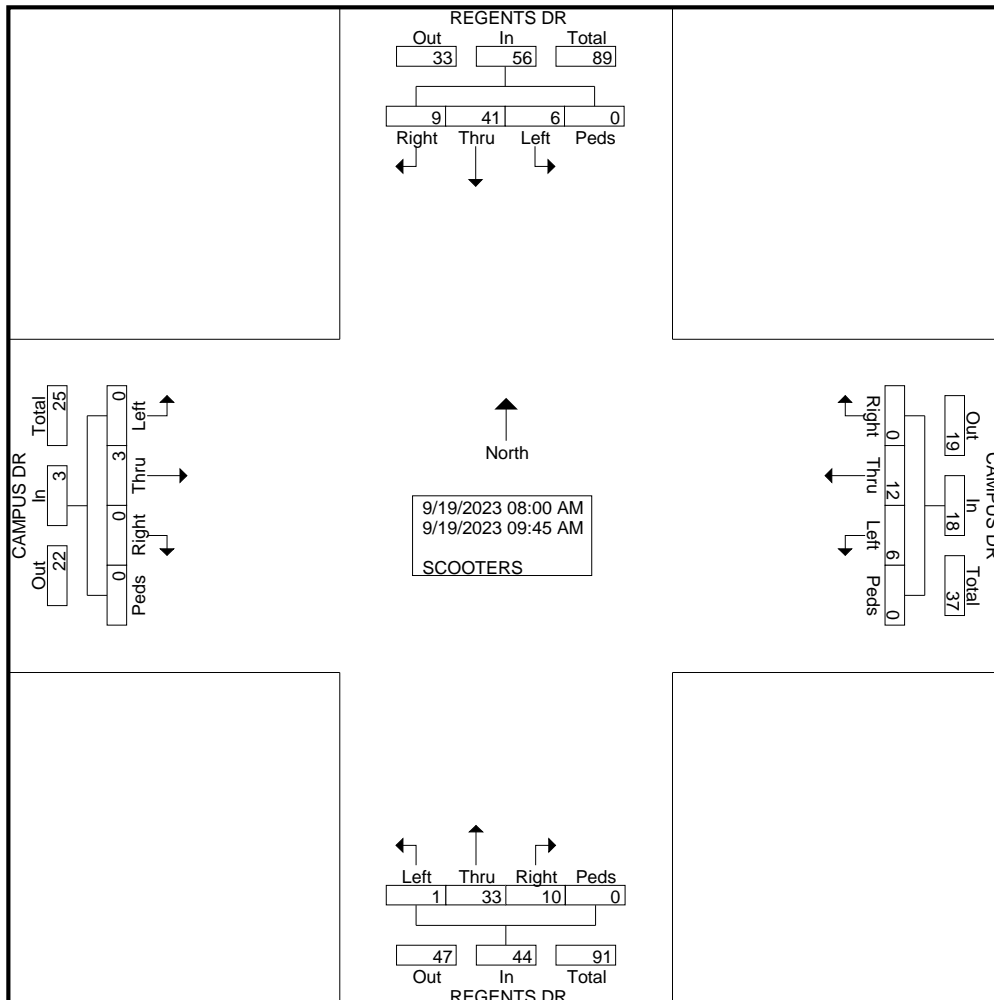

MEAD & HUNT

7055 Samuel Morse Dr. Ste. 100
Columbia, Maryland 21046

443-741-3500

MEAD & HUNT

7055 Samuel Morse Dr. Ste. 100
Columbia, Maryland 21046
443-741-3500

Weather:
Counted By:
Town:
Country

File Name : regents dr at campus dr
Site Code : 00000000
Start Date : 9/19/2023
Page No : 1

Groups Printed- BUSES

Start Time	REGENTS DR From North					CAMPUS DR From East					REGENTS DR From South					CAMPUS DR From West					Int. Total	
	Left	Thru	Right	Peds	App. Total	Left	Thru	Right	Peds	App. Total	Left	Thru	Right	Peds	App. Total	Left	Thru	Right	Peds	App. Total		
08:00 AM	1	1	2	0	4	0	4	1	0	5	0	1	0	0	1	0	0	0	0	0	0	10
08:15 AM	3	2	1	0	6	0	3	2	0	5	0	2	0	0	2	0	0	0	0	0	0	13
08:30 AM	1	1	3	0	5	0	3	0	0	3	0	0	0	0	0	0	0	0	0	0	0	8
08:45 AM	3	1	3	0	7	0	3	3	0	6	1	2	0	0	3	0	0	0	0	0	0	16
Total	8	5	9	0	22	0	13	6	0	19	1	5	0	0	6	0	0	0	0	0	0	47
09:00 AM	4	1	1	0	6	0	3	1	0	4	0	1	0	0	1	0	0	0	0	0	0	11
09:15 AM	1	1	5	0	7	0	3	1	0	4	0	0	0	0	0	0	0	0	0	0	0	11
09:30 AM	3	1	3	0	7	0	3	2	0	5	0	2	0	0	2	0	0	0	0	0	0	14
09:45 AM	4	1	2	0	7	0	5	2	0	7	1	1	0	0	2	0	0	0	0	0	0	16
Total	12	4	11	0	27	0	14	6	0	20	1	4	0	0	5	0	0	0	0	0	0	52
Grand Total	20	9	20	0	49	0	27	12	0	39	2	9	0	0	11	0	0	0	0	0	0	99
Apprch %	40.8	18.4	40.8	0		0	69.2	30.8	0		18.2	81.8	0	0		0	0	0	0	0	0	
Total %	20.2	9.1	20.2	0	49.5	0	27.3	12.1	0	39.4	2	9.1	0	0	11.1	0	0	0	0	0	0	

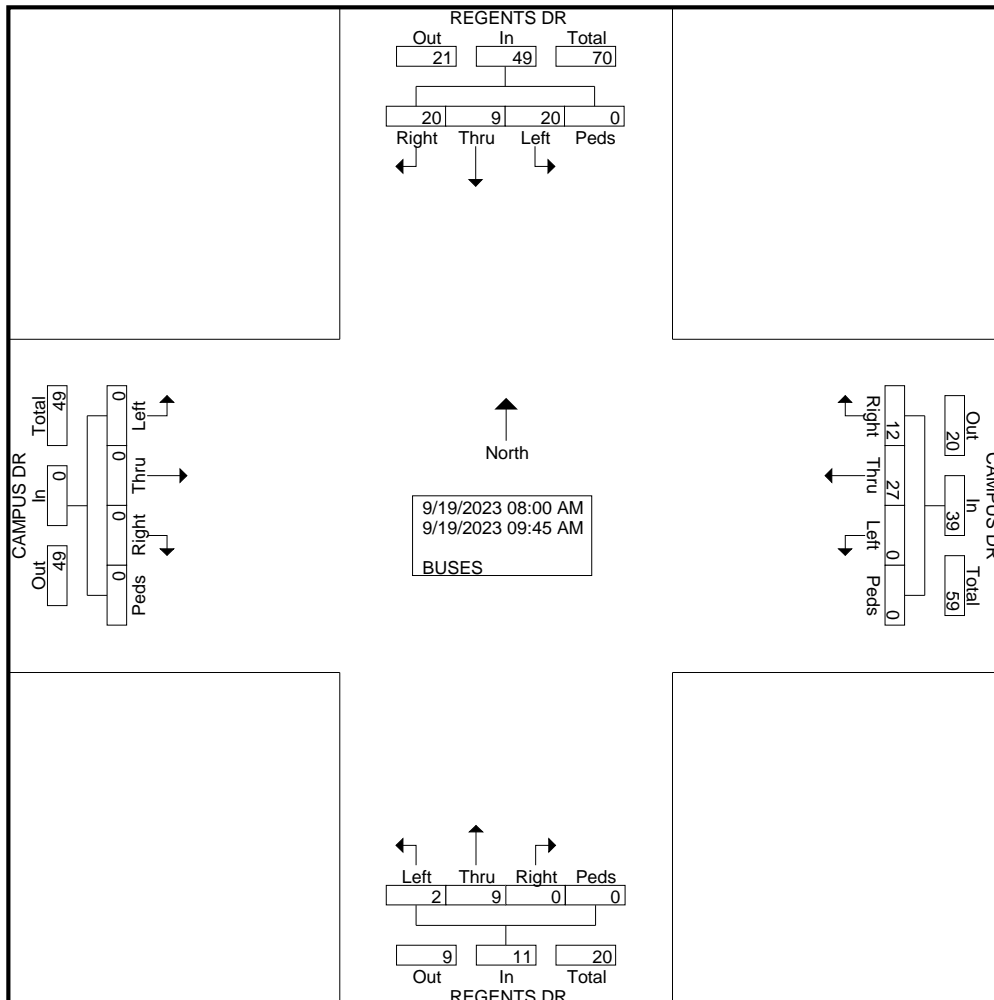

MEAD & HUNT

7055 Samuel Morse Dr. Ste. 100
Columbia, Maryland 21046
443-741-3500

File Name : regents dr at campus dr
Site Code : 00000000
Start Date : 9/19/2023
Page No : 2

Start Time	REGENTS DR From North					CAMPUS DR From East					REGENTS DR From South					CAMPUS DR From West					Int. Total
	Left	Thru	Right	Peds	App. Total	Left	Thru	Right	Peds	App. Total	Left	Thru	Right	Peds	App. Total	Left	Thru	Right	Peds	App. Total	
Peak Hour Analysis From 08:00 AM to 09:45 AM - Peak 1 of 1																					
Peak Hour for Entire Intersection Begins at 08:45 AM																					
08:45 AM	3	1	3	0	7	0	3	3	0	6	1	2	0	0	3	0	0	0	0	0	16
09:00 AM	4	1	1	0	6	0	3	1	0	4	0	1	0	0	1	0	0	0	0	0	11
09:15 AM	1	1	5	0	7	0	3	1	0	4	0	0	0	0	0	0	0	0	0	0	11
09:30 AM	3	1	3	0	7	0	3	2	0	5	0	2	0	0	2	0	0	0	0	0	14
Total Volume	11	4	12	0	27	0	12	7	0	19	1	5	0	0	6	0	0	0	0	0	52
% App. Total	40.7	14.8	44.4	0		0	63.2	36.8	0		16.7	83.3	0	0		0	0	0	0		
PHF	.688	1.00	.600	.000	.964	.000	1.00	.583	.000	.792	.250	.625	.000	.000	.500	.000	.000	.000	.000	.000	.813

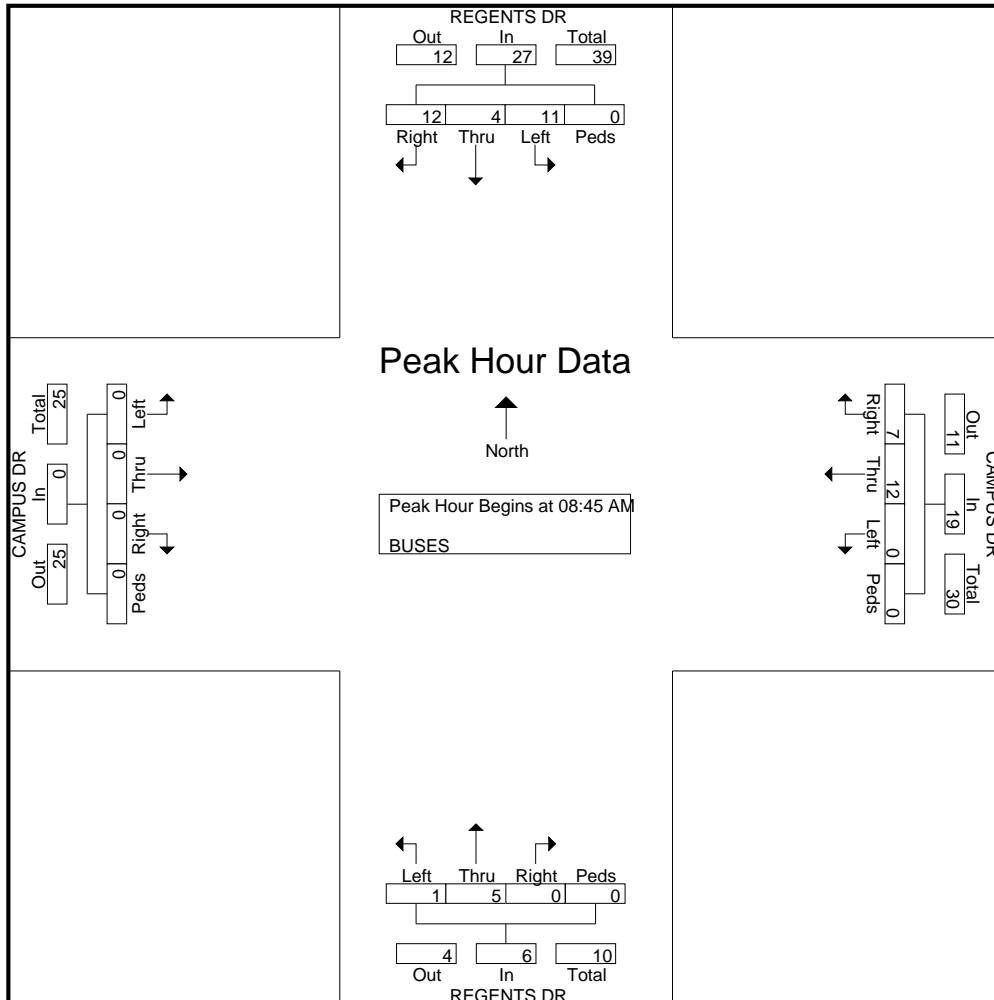

MEAD & HUNT

7055 Samuel Morse Dr. Ste. 100
Columbia, Maryland 21046

443-741-3500

Weather:
Counted By:
Town:
Country

File Name : regents dr at campus dr
Site Code : 00000000
Start Date : 9/19/2023
Page No : 1

Groups Printed- U TURNS

Start Time	REGENTS DR From North					CAMPUS DR From East					REGENTS DR From South					CAMPUS DR From West					Int. Total	
	Left	Thru	Right	Peds	App. Total	Left	Thru	Right	Peds	App. Total	Left	Thru	Right	Peds	App. Total	Left	Thru	Right	Peds	App. Total		
*** BREAK ***																						
08:15 AM	0	0	0	0	0	1	0	0	0	1	0	0	0	0	0	0	0	0	0	0	0	1
*** BREAK ***																						
Total	0	0	0	0	0	1	0	0	0	1	0	0	0	0	0	0	0	0	0	0	0	1
*** BREAK ***																						
09:30 AM	0	0	0	0	0	0	0	0	0	0	1	0	0	0	1	0	0	0	0	0	0	1
*** BREAK ***																						
Total	0	0	0	0	0	0	0	0	0	0	1	0	0	0	1	0	0	0	0	0	0	1
Grand Total	0	0	0	0	0	1	0	0	0	1	1	0	0	0	1	0	0	0	0	0	0	2
Apprch %	0	0	0	0	0	100	0	0	0	50	100	0	0	0	50	0	0	0	0	0	0	
Total %	0	0	0	0	0	50	0	0	0	50	50	0	0	0	50	0	0	0	0	0	0	

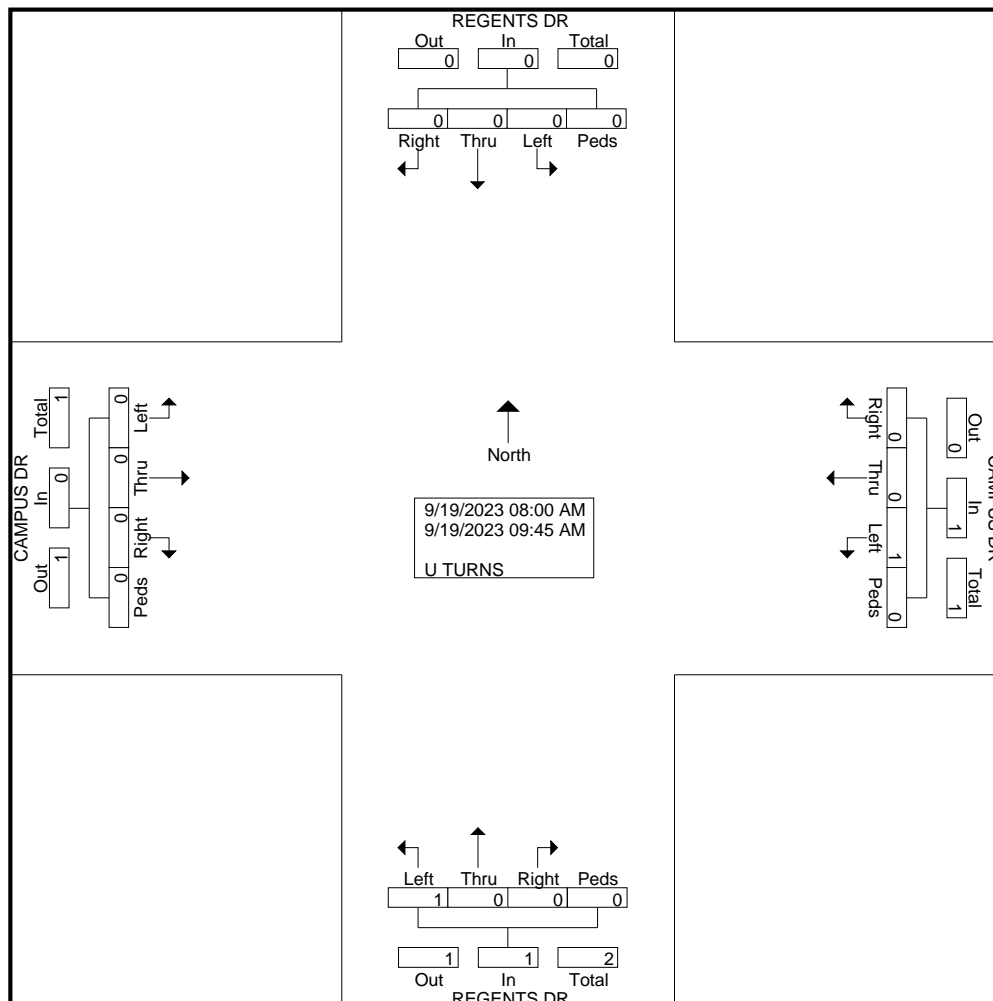

MEAD & HUNT

7055 Samuel Morse Dr. Ste. 100
Columbia, Maryland 21046

443-741-3500

MEAD & HUNT

7055 Samuel Morse Dr. Ste. 100
Columbia, Maryland 21046

443-741-3500

Weather:
Counted By:
Town:
Country

File Name : regents dr at paint branch dr
Site Code : 00000000
Start Date : 9/19/2023
Page No : 1

Groups Printed- VEHS&PEDS

Start Time	PAINT BRANCH DR From North					PARKING LOT From East					PAINT BRANCH DR From South					REGENTS DR From West					Int. Total
	Left	Thru	Right	Peds	App. Total	Left	Thru	Right	Peds	App. Total	Left	Thru	Right	Peds	App. Total	Left	Thru	Right	Peds	App. Total	
08:00 AM	1	30	44	2	77	0	0	1	4	5	9	23	1	0	33	12	0	0	11	23	138
08:15 AM	2	30	46	6	84	0	0	3	7	10	7	21	4	0	32	16	1	1	9	27	153
08:30 AM	3	29	46	9	87	3	0	1	10	14	11	20	7	0	38	16	2	6	5	29	168
08:45 AM	7	31	63	5	106	1	0	1	19	21	22	26	9	0	57	18	0	3	18	39	223
Total	13	120	199	22	354	4	0	6	40	50	49	90	21	0	160	62	3	10	43	118	682
09:00 AM	12	35	69	4	120	0	1	0	13	14	18	37	8	0	63	12	1	1	21	35	232
09:15 AM	7	35	75	22	139	0	0	7	46	53	19	24	13	1	57	16	1	1	26	44	293
09:30 AM	1	34	80	8	123	0	0	2	33	35	17	26	6	0	49	15	2	9	12	38	245
09:45 AM	2	20	39	9	70	4	0	1	21	26	12	20	5	0	37	16	0	3	10	29	162
Total	22	124	263	43	452	4	1	10	113	128	66	107	32	1	206	59	4	14	69	146	932
*** BREAK ***																					
03:30 PM	2	28	22	7	59	4	1	10	21	36	2	18	0	0	20	66	0	12	10	88	203
03:45 PM	3	23	32	18	76	7	1	4	20	32	8	18	1	0	27	44	1	3	7	55	190
Total	5	51	54	25	135	11	2	14	41	68	10	36	1	0	47	110	1	15	17	143	393
04:00 PM	2	27	26	7	62	3	1	5	20	29	4	32	1	2	39	50	1	4	16	71	201
04:15 PM	3	22	27	5	57	4	0	4	13	21	7	28	9	0	44	48	0	6	8	62	184
04:30 PM	2	25	19	8	54	7	2	7	19	35	6	15	2	1	24	55	6	3	13	77	190
04:45 PM	2	35	28	7	72	8	1	5	27	41	6	18	0	0	24	65	3	3	22	93	230
Total	9	109	100	27	245	22	4	21	79	126	23	93	12	3	131	218	10	16	59	303	805
05:00 PM	3	34	35	13	85	7	0	13	31	51	2	17	8	1	28	60	1	10	19	90	254
05:15 PM	2	31	30	31	94	7	3	14	54	78	8	33	7	2	50	49	6	10	13	78	300
Grand Total	54	469	681	161	1365	55	10	78	358	501	158	376	81	7	622	558	25	75	220	878	3366
Apprch %	4	34.4	49.9	11.8		11	2	15.6	71.5		25.4	60.5	13	1.1		63.6	2.8	8.5	25.1		
Total %	1.6	13.9	20.2	4.8	40.6	1.6	0.3	2.3	10.6	14.9	4.7	11.2	2.4	0.2	18.5	16.6	0.7	2.2	6.5	26.1	

MEAD & HUNT

7055 Samuel Morse Dr. Ste. 100
Columbia, Maryland 21046

443-741-3500

File Name : regents dr at paint branch dr

Site Code : 00000000

Start Date : 9/19/2023

Page No : 2

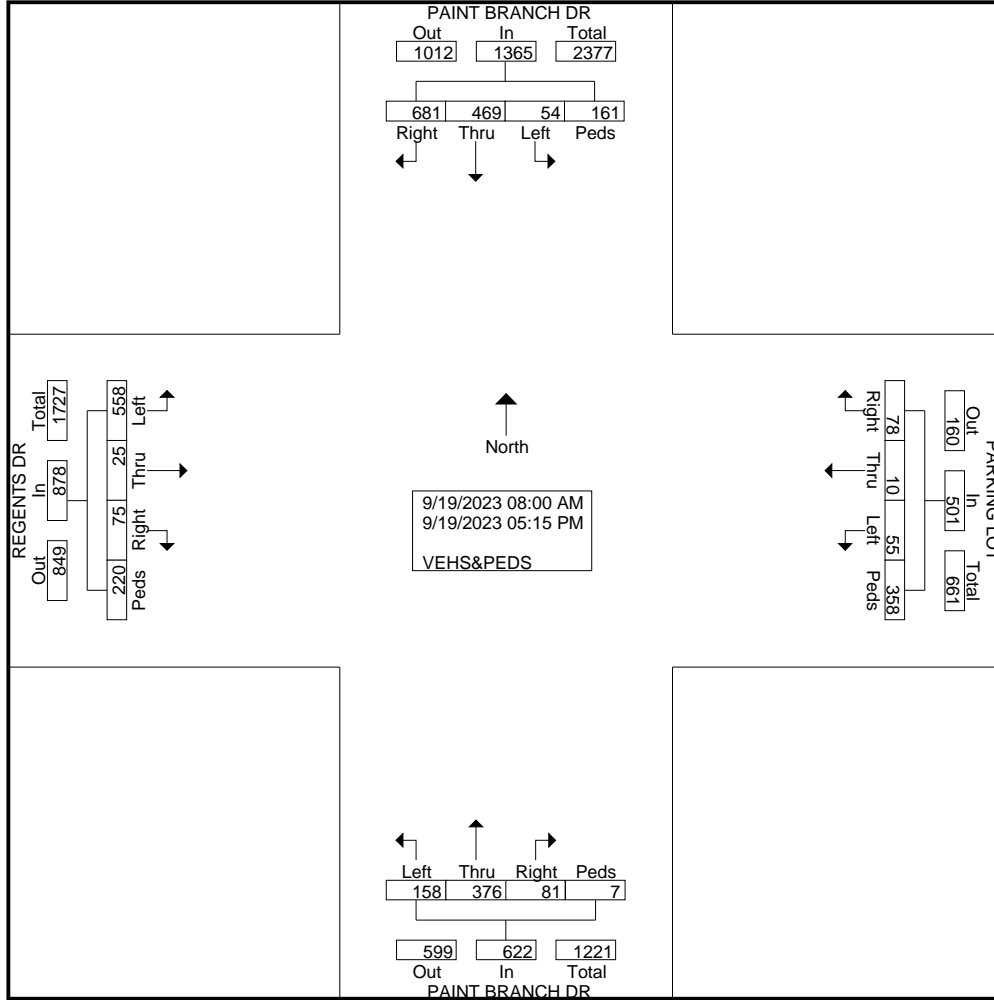

MEAD & HUNT

7055 Samuel Morse Dr. Ste. 100
Columbia, Maryland 21046
443-741-3500

File Name : regents dr at paint branch dr
Site Code : 00000000
Start Date : 9/19/2023
Page No : 3

Start Time	PAINT BRANCH DR From North					PARKING LOT From East					PAINT BRANCH DR From South					REGENTS DR From West					Int. Total
	Left	Thru	Right	Peds	App. Total	Left	Thru	Right	Peds	App. Total	Left	Thru	Right	Peds	App. Total	Left	Thru	Right	Peds	App. Total	
Peak Hour Analysis From 08:00 AM to 12:45 PM - Peak 1 of 1																					
Peak Hour for Entire Intersection Begins at 08:45 AM																					
08:45 AM	7	31	63	5	106	1	0	1	19	21	22	26	9	0	57	18	0	3	18	39	223
09:00 AM	12	35	69	4	120	0	1	0	13	14	18	37	8	0	63	12	1	1	21	35	232
09:15 AM	7	35	75	22	139	0	0	7	46	53	19	24	13	1	57	16	1	1	26	44	293
09:30 AM	1	34	80	8	123	0	0	2	33	35	17	26	6	0	49	15	2	9	12	38	245
Total Volume	27	135	287	39	488	1	1	10	111	123	76	113	36	1	226	61	4	14	77	156	993
% App. Total	5.5	27.7	58.8	8		0.8	0.8	8.1	90.2		33.6	50	15.9	0.4		39.1	2.6	9	49.4		
PHF	.563	.964	.897	.443	.878	.250	.250	.357	.603	.580	.864	.764	.692	.250	.897	.847	.500	.389	.740	.886	.847

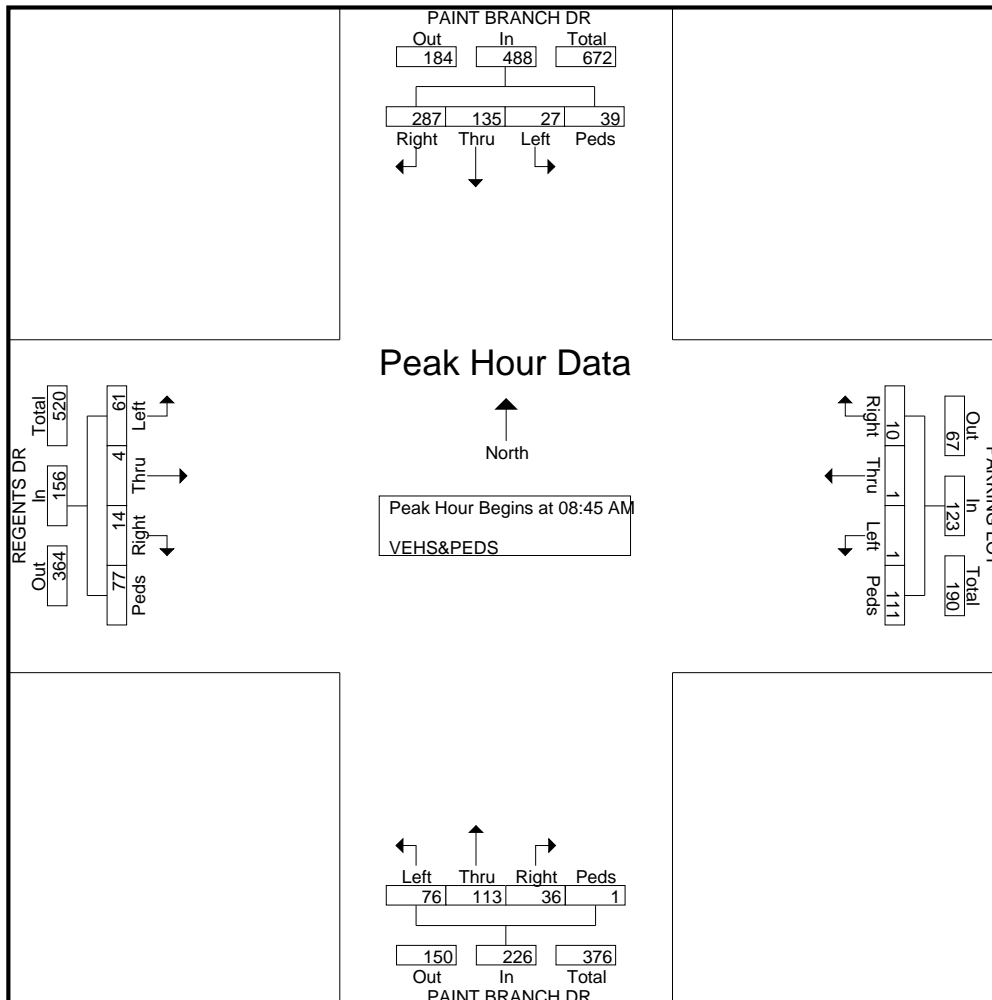

MEAD & HUNT

7055 Samuel Morse Dr. Ste. 100
Columbia, Maryland 21046
443-741-3500

File Name : regents dr at paint branch dr
Site Code : 00000000
Start Date : 9/19/2023
Page No : 4

Start Time	PAINT BRANCH DR From North					PARKING LOT From East					PAINT BRANCH DR From South					REGENTS DR From West					Int. Total
	Left	Thru	Right	Peds	App. Total	Left	Thru	Right	Peds	App. Total	Left	Thru	Right	Peds	App. Total	Left	Thru	Right	Peds	App. Total	

Peak Hour Analysis From 01:00 PM to 05:15 PM - Peak 1 of 1

Peak Hour for Entire Intersection Begins at 04:30 PM

04:30 PM	2	25	19	8	54	7	2	7	19	35	6	15	2	1	24	55	6	3	13	77	190
04:45 PM	2	35	28	7	72	8	1	5	27	41	6	18	0	0	24	65	3	3	22	93	230
05:00 PM	3	34	35	13	85	7	0	13	31	51	2	17	8	1	28	60	1	10	19	90	254
05:15 PM	2	31	30	31	94	7	3	14	54	78	8	33	7	2	50	49	6	10	13	78	300
Total Volume	9	125	112	59	305	29	6	39	131	205	22	83	17	4	126	229	16	26	67	338	974
% App. Total	3	41	36.7	19.3		14.1	2.9	19	63.9		17.5	65.9	13.5	3.2		67.8	4.7	7.7	19.8		
PHF	.750	.893	.800	.476	.811	.906	.500	.696	.606	.657	.688	.629	.531	.500	.630	.881	.667	.650	.761	.909	.812

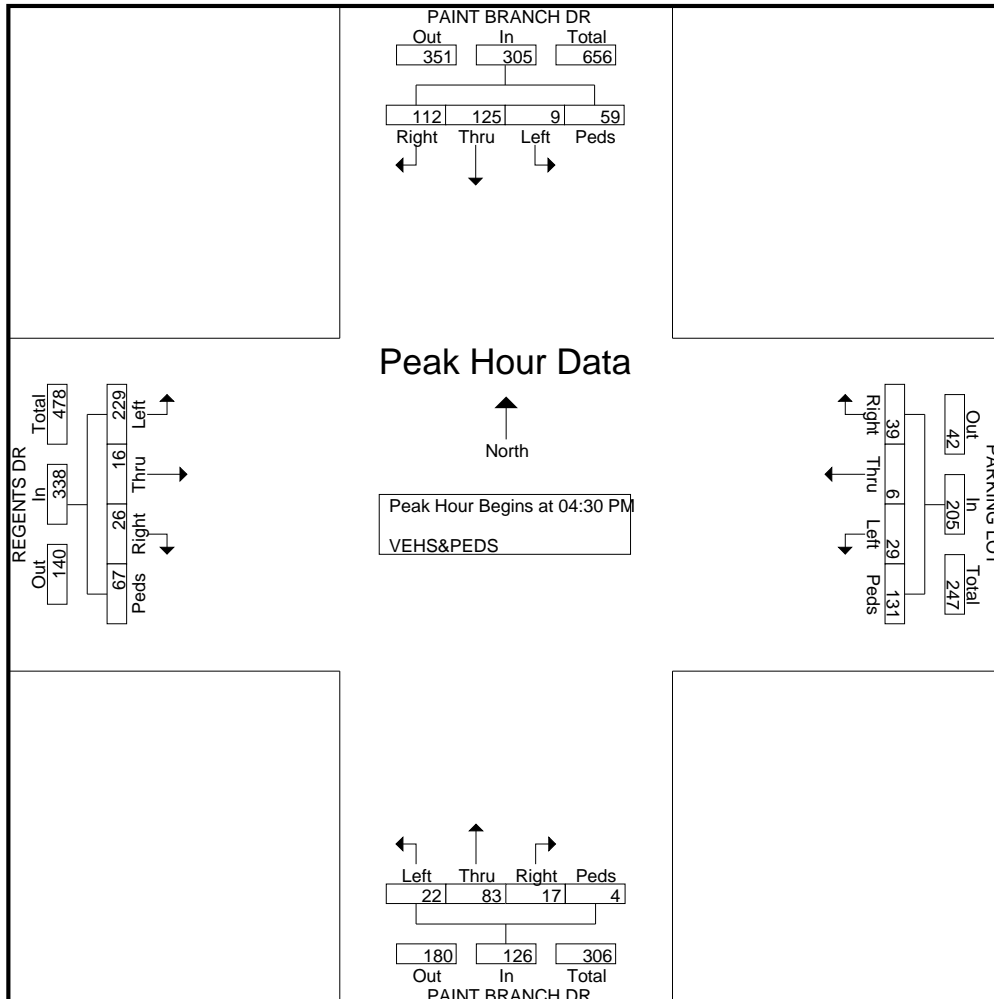

MEAD & HUNT

7055 Samuel Morse Dr. Ste. 100

Columbia, Maryland 21046

443-741-3500

Weather:
 Counted By:
 Town:
 Country

File Name : regents dr at paint branch dr
 Site Code : 00000000
 Start Date : 9/19/2023
 Page No : 1

Groups Printed- BICYCLES

Start Time	PAINT BRANCH DR From North					PARKING LOT From East					PAINT BRANCH DR From South					REGENTS DR From West					Int. Total
	Left	Thru	Right	Peds	App. Total	Left	Thru	Right	Peds	App. Total	Left	Thru	Right	Peds	App. Total	Left	Thru	Right	Peds	App. Total	
08:00 AM	0	0	0	0	0	0	0	0	2	2	0	0	0	0	0	0	0	1	1	2	4
08:15 AM	0	1	2	0	3	0	0	0	0	0	1	0	0	0	1	0	0	2	0	2	6
08:30 AM	0	0	0	0	0	0	0	0	0	0	0	0	0	0	0	0	0	0	2	2	2
08:45 AM	0	4	0	0	4	0	0	0	0	0	0	0	0	0	0	0	0	0	3	3	7
Total	0	5	2	0	7	0	0	0	2	2	1	0	0	0	1	0	0	3	6	9	19
09:00 AM	0	6	0	0	6	0	0	0	0	0	1	0	0	0	1	0	0	1	1	2	9
09:15 AM	0	1	0	1	2	0	0	0	0	0	0	0	0	0	0	0	0	1	11	12	14
09:30 AM	0	2	0	0	2	0	0	0	0	0	1	0	0	0	1	0	0	1	4	5	8
09:45 AM	0	1	0	0	1	0	0	0	0	0	1	0	0	0	1	0	3	0	2	5	7
Total	0	10	0	1	11	0	0	0	0	0	3	0	0	0	3	0	3	3	18	24	38
*** BREAK ***																					
03:30 PM	0	1	1	0	2	0	0	0	1	1	0	0	0	0	0	2	1	0	1	4	7
03:45 PM	0	0	0	1	1	0	0	0	1	1	0	0	0	0	0	1	0	0	0	1	3
Total	0	1	1	1	3	0	0	0	2	2	0	0	0	0	0	3	1	0	1	5	10
04:00 PM	0	2	0	0	2	0	0	0	0	0	0	0	0	0	0	1	3	0	0	4	6
04:15 PM	0	0	0	0	0	0	0	0	0	0	0	0	0	0	0	1	1	0	1	3	3
04:30 PM	0	0	0	0	0	0	0	0	1	1	0	1	1	0	2	0	0	0	0	0	3
04:45 PM	0	0	0	1	1	0	2	0	0	2	0	8	0	0	8	0	0	0	0	0	11
Total	0	2	0	1	3	0	2	0	1	3	0	9	1	0	10	2	4	0	1	7	23
05:00 PM	0	0	0	1	1	0	4	0	2	6	0	2	0	0	2	0	0	0	2	2	11
05:15 PM	0	0	0	1	1	0	4	0	1	5	0	1	0	0	1	0	0	0	1	1	8
Grand Total	0	18	3	5	26	0	10	0	8	18	4	12	1	0	17	5	8	6	29	48	109
Apprch %	0	69.2	11.5	19.2		0	55.6	0	44.4		23.5	70.6	5.9	0		10.4	16.7	12.5	60.4		
Total %	0	16.5	2.8	4.6	23.9	0	9.2	0	7.3	16.5	3.7	11	0.9	0	15.6	4.6	7.3	5.5	26.6	44	

MEAD & HUNT

7055 Samuel Morse Dr. Ste. 100
Columbia, Maryland 21046

443-741-3500

File Name : regents dr at paint branch dr

Site Code : 00000000

Start Date : 9/19/2023

Page No : 2

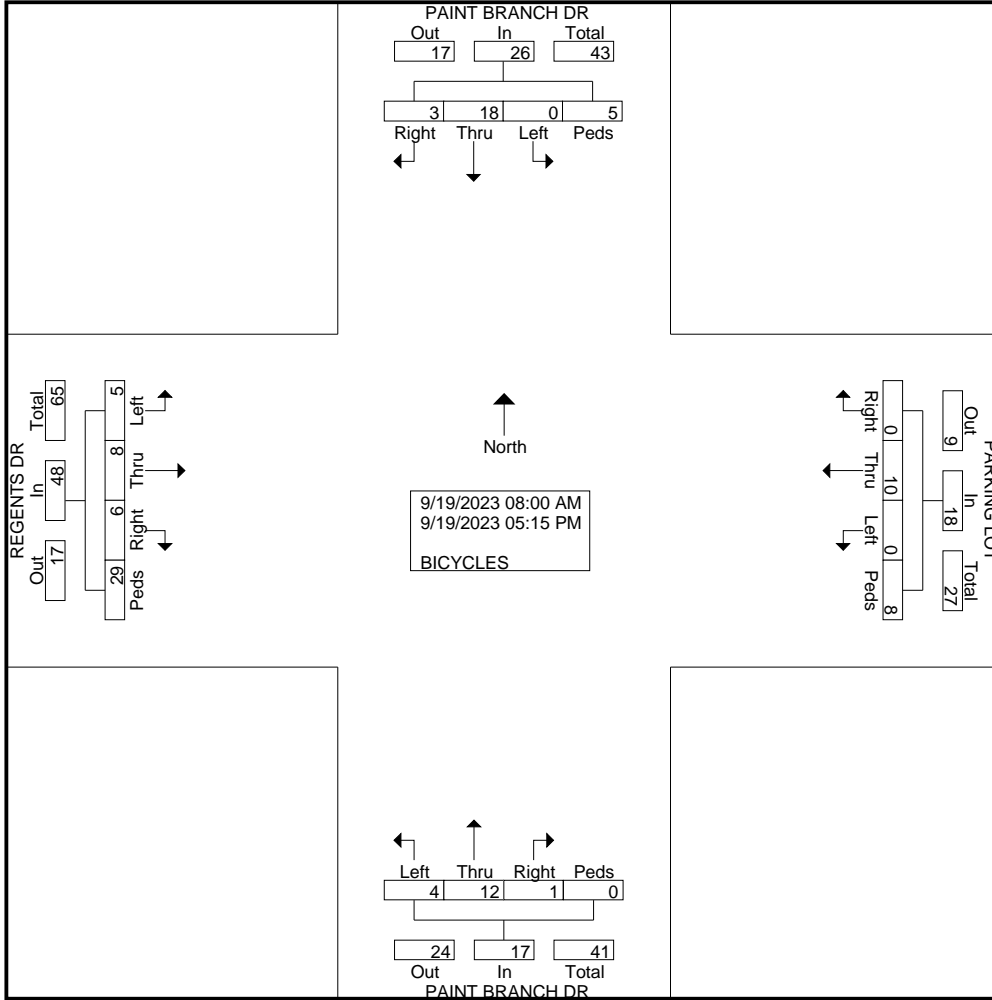

MEAD & HUNT

7055 Samuel Morse Dr. Ste. 100
Columbia, Maryland 21046

443-741-3500

Weather:
Counted By:
Town:
Country

File Name : regents dr at paint branch dr
Site Code : 00000000
Start Date : 9/19/2023
Page No : 1

Groups Printed- SCOOTERS

Start Time	PAINT BRANCH DR From North					PARKING LOT From East					PAINT BRANCH DR From South					REGENTS DR From West					Int. Total
	Left	Thru	Right	Peds	App. Total	Left	Thru	Right	Peds	App. Total	Left	Thru	Right	Peds	App. Total	Left	Thru	Right	Peds	App. Total	
08:00 AM	0	1	0	0	1	0	0	0	0	0	1	0	0	0	1	0	0	1	0	1	3
*** BREAK ***																					
08:45 AM	0	1	1	0	2	0	1	0	0	1	0	0	0	0	0	0	0	2	0	2	5
Total	0	2	1	0	3	0	1	0	0	1	1	0	0	0	1	0	0	3	0	3	8
*** BREAK ***																					
09:45 AM	0	0	0	0	0	0	0	0	0	0	0	1	0	0	1	0	0	0	0	0	1
Total	0	0	0	0	0	0	0	0	0	0	0	1	0	0	1	0	0	0	0	0	1
*** BREAK ***																					
03:30 PM	0	0	0	0	0	0	0	0	0	0	0	1	0	0	1	0	0	0	0	0	1
03:45 PM	0	0	0	0	0	0	0	0	0	0	0	1	1	0	2	0	0	0	0	0	2
Total	0	0	0	0	0	0	0	0	0	0	0	2	1	0	3	0	0	0	0	0	3
*** BREAK ***																					
Grand Total	0	2	1	0	3	0	1	0	0	1	1	3	1	0	5	0	0	3	0	3	12
Apprch %	0	66.7	33.3	0		0	100	0	0		20	60	20	0		0	0	100	0		
Total %	0	16.7	8.3	0	25	0	8.3	0	0	8.3	8.3	25	8.3	0	41.7	0	0	25	0	25	

MEAD & HUNT

7055 Samuel Morse Dr. Ste. 100
Columbia, Maryland 21046

443-741-3500

File Name : regents dr at paint branch dr

Site Code : 00000000

Start Date : 9/19/2023

Page No : 2

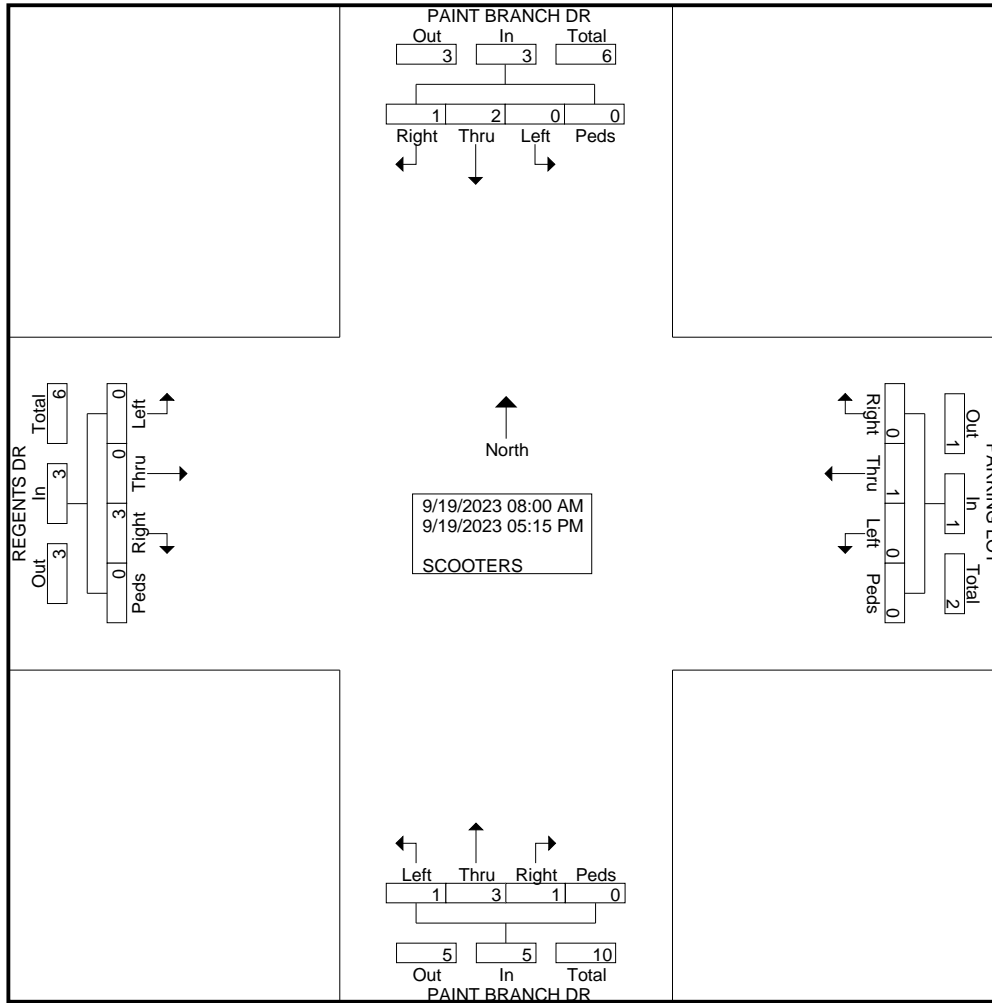

MEAD & HUNT

7055 Samuel Morse Dr. Ste. 100

Columbia, Maryland 21046

443-741-3500

Weather:
 Counted By:
 Town:
 Country

File Name : regents dr at paint branch dr
 Site Code : 00000000
 Start Date : 9/19/2023
 Page No : 1

Groups Printed- SKATEBOARDS

Start Time	PAINT BRANCH DR From North					PARKING LOT From East					PAINT BRANCH DR From South					REGENTS DR From West					Int. Total
	Left	Thru	Right	Peds	App. Total	Left	Thru	Right	Peds	App. Total	Left	Thru	Right	Peds	App. Total	Left	Thru	Right	Peds	App. Total	
*** BREAK ***																					
08:45 AM	0	0	0	0	0	0	0	0	1	1	0	0	0	0	0	0	0	0	0	0	1
Total	0	0	0	0	0	0	0	0	1	1	0	0	0	0	0	0	0	0	0	0	1
*** BREAK ***																					
09:15 AM	0	0	0	1	1	0	0	0	3	3	0	0	0	0	0	0	0	0	0	0	4
*** BREAK ***																					
09:45 AM	0	0	0	2	2	0	0	0	0	0	0	0	0	0	0	0	0	0	0	0	2
Total	0	0	0	3	3	0	0	0	3	3	0	0	0	0	0	0	0	0	0	0	6
*** BREAK ***																					
03:30 PM	0	0	0	0	0	0	0	0	4	4	0	0	0	0	0	0	0	0	0	0	4
03:45 PM	0	0	0	0	0	0	0	0	2	2	0	0	0	0	0	0	0	0	0	0	2
Total	0	0	0	0	0	0	0	0	6	6	0	0	0	0	0	0	0	0	0	0	6
04:00 PM	0	0	0	1	1	0	0	0	5	5	0	0	0	0	0	0	0	0	0	0	6
*** BREAK ***																					
Total	0	0	0	1	1	0	0	0	5	5	0	0	0	0	0	0	0	0	0	0	6
*** BREAK ***																					
Grand Total	0	0	0	4	4	0	0	0	15	15	0	0	0	0	0	0	0	0	0	0	19
Apprch %	0	0	0	100		0	0	0	100		0	0	0	0		0	0	0	0		
Total %	0	0	0	21.1	21.1	0	0	0	78.9	78.9	0	0	0	0	0	0	0	0	0	0	

MEAD & HUNT

7055 Samuel Morse Dr. Ste. 100
Columbia, Maryland 21046

443-741-3500

File Name : regents dr at paint branch dr

Site Code : 00000000

Start Date : 9/19/2023

Page No : 2

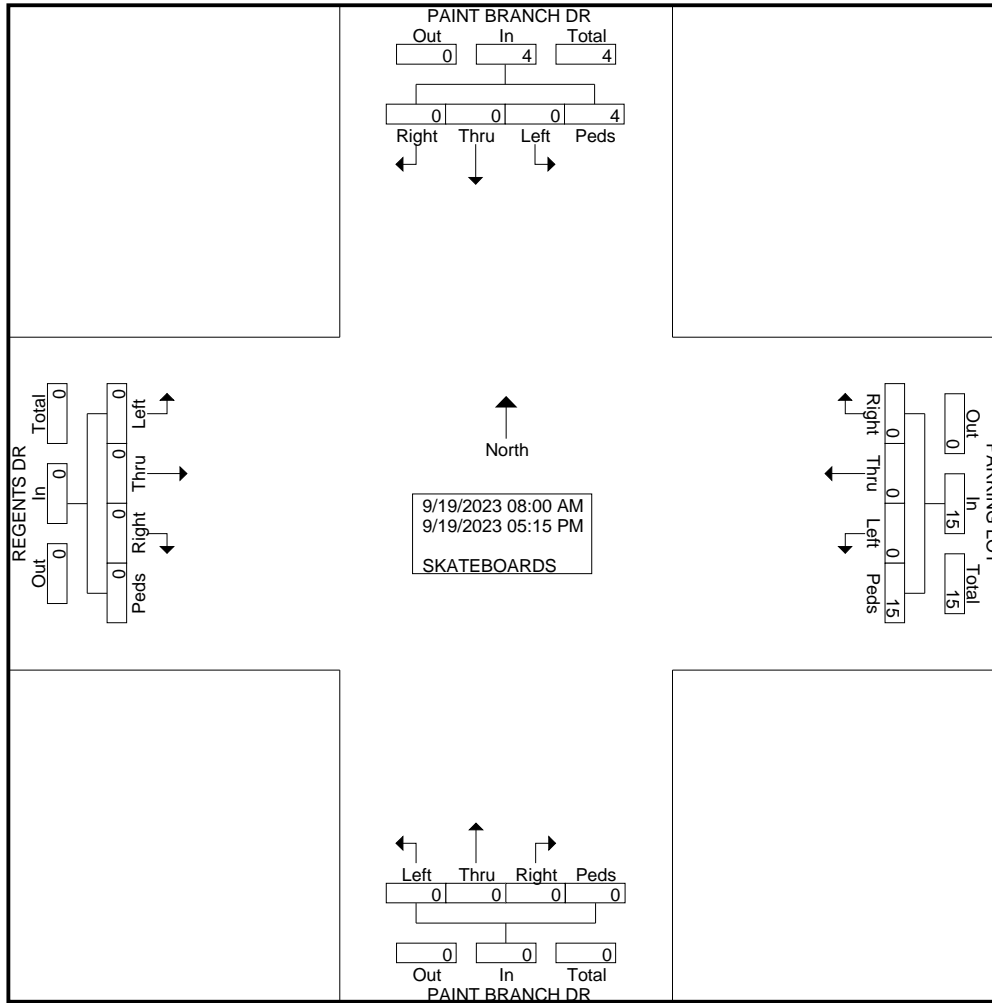

MEAD & HUNT

7055 Samuel Morse Dr. Ste. 100
Columbia, Maryland 21046

443-741-3500

Weather:
Counted By:
Town:
Country

File Name : regents dr at paint branch dr
Site Code : 00000000
Start Date : 9/19/2023
Page No : 1

Groups Printed- BUSES

Start Time	PAINT BRANCH DR From North					PARKING LOT From East					PAINT BRANCH DR From South					REGENTS DR From West					Int. Total
	Left	Thru	Right	Peds	App. Total	Left	Thru	Right	Peds	App. Total	Left	Thru	Right	Peds	App. Total	Left	Thru	Right	Peds	App. Total	
08:00 AM	0	1	1	0	2	0	0	0	0	0	3	1	0	0	4	1	0	0	0	1	7
08:15 AM	0	0	2	0	2	0	0	0	0	0	3	0	0	0	3	1	0	0	0	1	6
08:30 AM	0	1	2	0	3	0	0	0	0	0	1	1	0	0	2	1	0	0	0	1	6
08:45 AM	0	1	1	0	2	0	0	0	0	0	3	0	1	0	4	1	0	0	0	1	7
Total	0	3	6	0	9	0	0	0	0	0	10	2	1	0	13	4	0	0	0	4	26
09:00 AM	0	1	2	0	3	0	0	0	0	0	1	2	0	0	3	1	0	0	0	1	7
09:15 AM	0	0	1	0	1	0	0	0	0	0	3	1	0	0	4	1	0	0	0	1	6
09:30 AM	0	0	3	0	3	0	0	0	0	0	1	1	0	0	2	0	0	0	0	0	5
09:45 AM	0	0	1	0	1	0	0	0	0	0	3	1	0	0	4	3	0	0	0	3	8
Total	0	1	7	0	8	0	0	0	0	0	8	5	0	0	13	5	0	0	0	5	26
*** BREAK ***																					
03:30 PM	0	0	2	0	2	0	0	0	0	0	0	2	0	0	2	2	0	0	0	2	6
03:45 PM	0	0	3	0	3	0	0	0	0	0	3	1	0	0	4	1	0	0	0	1	8
Total	0	0	5	0	5	0	0	0	0	0	3	3	0	0	6	3	0	0	0	3	14
04:00 PM	0	0	2	0	2	0	0	0	0	0	1	2	0	0	3	2	0	0	0	2	7
04:15 PM	0	0	2	0	2	0	0	0	0	0	2	1	0	0	3	1	0	0	0	1	6
04:30 PM	0	0	1	0	1	0	0	0	0	0	2	1	0	0	3	1	0	0	0	1	5
04:45 PM	0	0	2	0	2	0	0	0	0	0	2	0	0	0	2	1	0	0	0	1	5
Total	0	0	7	0	7	0	0	0	0	0	7	4	0	0	11	5	0	0	0	5	23
05:00 PM	0	0	2	0	2	0	0	0	0	0	2	1	0	0	3	1	0	0	0	1	6
05:15 PM	0	0	2	0	2	0	0	0	0	0	1	1	0	0	2	1	0	0	0	1	5
Grand Total	0	4	29	0	33	0	0	0	0	0	31	16	1	0	48	19	0	0	0	19	100
Apprch %	0	12.1	87.9	0		0	0	0	0		64.6	33.3	2.1	0		100	0	0	0		
Total %	0	4	29	0	33	0	0	0	0	0	31	16	1	0	48	19	0	0	0	19	

MEAD & HUNT

7055 Samuel Morse Dr. Ste. 100
Columbia, Maryland 21046

443-741-3500

File Name : regents dr at paint branch dr

Site Code : 00000000

Start Date : 9/19/2023

Page No : 2

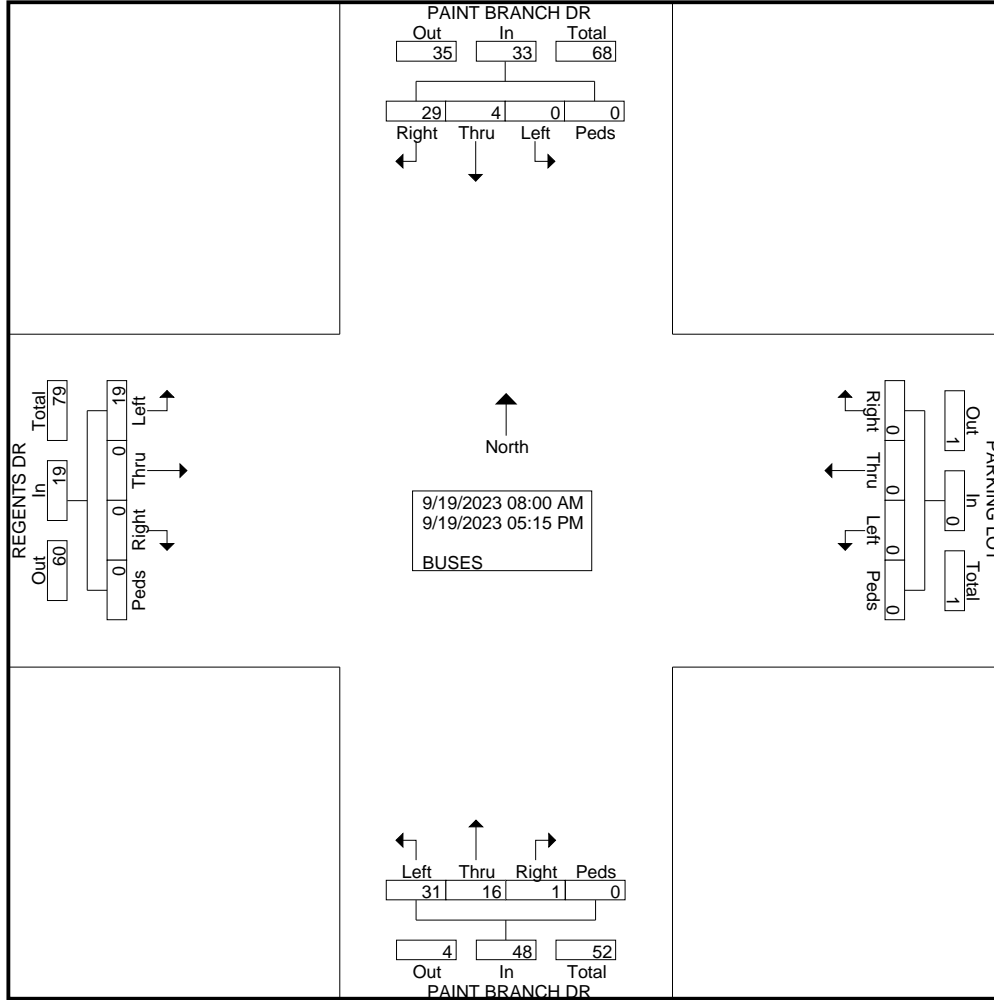

MEAD & HUNT

7055 Samuel Morse Dr. Ste. 100
Columbia, Maryland 21046

443-741-3500

File Name : regents dr at paint branch dr

Site Code : 00000000

Start Date : 9/19/2023

Page No : 3

Start Time	PAINT BRANCH DR From North					PARKING LOT From East					PAINT BRANCH DR From South					REGENTS DR From West					Int. Total
	Left	Thru	Right	Peds	App. Total	Left	Thru	Right	Peds	App. Total	Left	Thru	Right	Peds	App. Total	Left	Thru	Right	Peds	App. Total	
Peak Hour Analysis From 08:00 AM to 12:45 PM - Peak 1 of 1																					
Peak Hour for Entire Intersection Begins at 08:00 AM																					
08:00 AM	0	1	1	0	2	0	0	0	0	0	3	1	0	0	4	1	0	0	0	1	7
08:15 AM	0	0	2	0	2	0	0	0	0	0	3	0	0	0	3	1	0	0	0	1	6
08:30 AM	0	1	2	0	3	0	0	0	0	0	1	1	0	0	2	1	0	0	0	1	6
08:45 AM	0	1	1	0	2	0	0	0	0	0	3	0	1	0	4	1	0	0	0	1	7
Total Volume	0	3	6	0	9	0	0	0	0	0	10	2	1	0	13	4	0	0	0	4	26
% App. Total	0	33.3	66.7	0		0	0	0	0		76.9	15.4	7.7	0		100	0	0	0		
PHF	.000	.750	.750	.000	.750	.000	.000	.000	.000	.000	.833	.500	.250	.000	.813	1.00	.000	.000	.000	1.00	.929

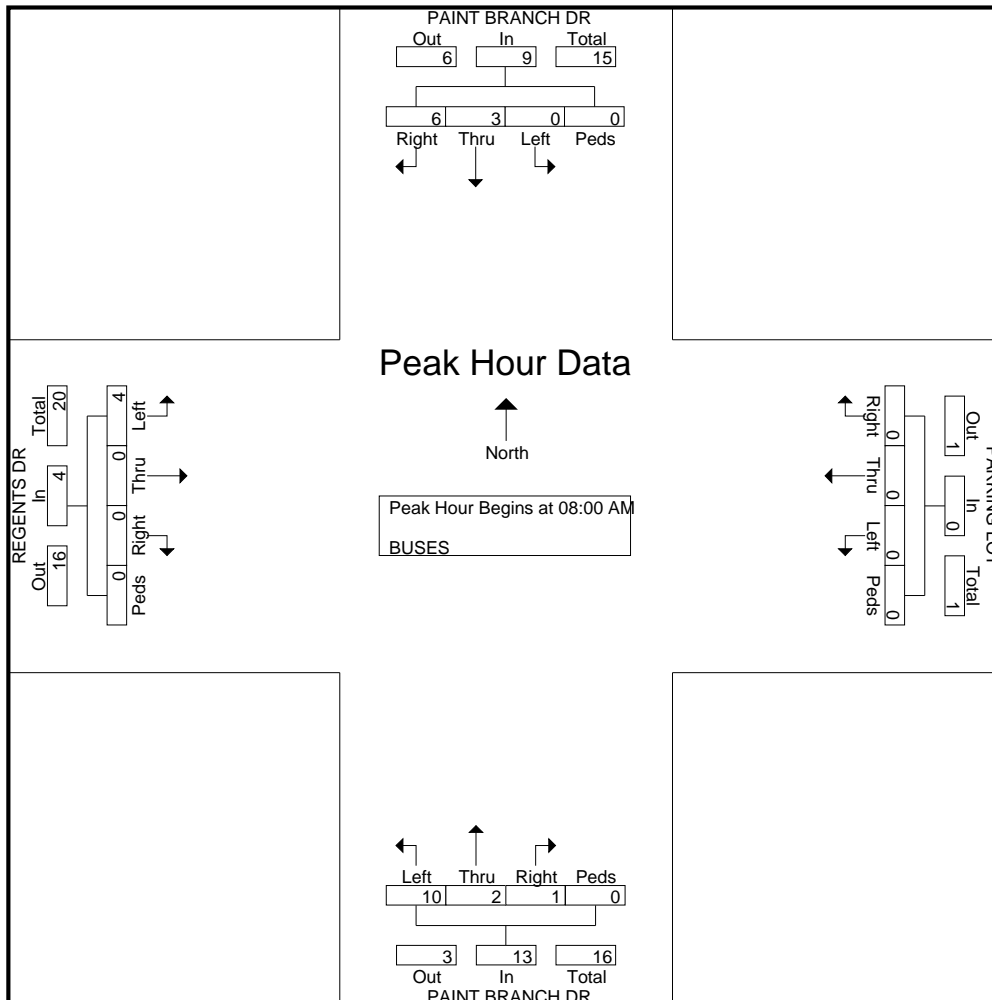

MEAD & HUNT

7055 Samuel Morse Dr. Ste. 100
Columbia, Maryland 21046
443-741-3500

File Name : regents dr at paint branch dr
Site Code : 00000000
Start Date : 9/19/2023
Page No : 4

Start Time	PAINT BRANCH DR From North					PARKING LOT From East					PAINT BRANCH DR From South					REGENTS DR From West					Int. Total
	Left	Thru	Right	Peds	App. Total	Left	Thru	Right	Peds	App. Total	Left	Thru	Right	Peds	App. Total	Left	Thru	Right	Peds	App. Total	
Peak Hour Analysis From 01:00 PM to 05:15 PM - Peak 1 of 1																					
Peak Hour for Entire Intersection Begins at 03:30 PM																					
03:30 PM	0	0	2	0	2	0	0	0	0	0	0	2	0	0	2	2	0	0	0	2	6
03:45 PM	0	0	3	0	3	0	0	0	0	0	3	1	0	0	4	1	0	0	0	1	8
04:00 PM	0	0	2	0	2	0	0	0	0	0	1	2	0	0	3	2	0	0	0	2	7
04:15 PM	0	0	2	0	2	0	0	0	0	0	2	1	0	0	3	1	0	0	0	1	6
Total Volume	0	0	9	0	9	0	0	0	0	0	6	6	0	0	12	6	0	0	0	6	27
% App. Total	0	0	100	0		0	0	0	0		50	50	0	0		100	0	0	0		
PHF	.000	.000	.750	.000	.750	.000	.000	.000	.000	.000	.500	.750	.000	.000	.750	.750	.000	.000	.000	.750	.844

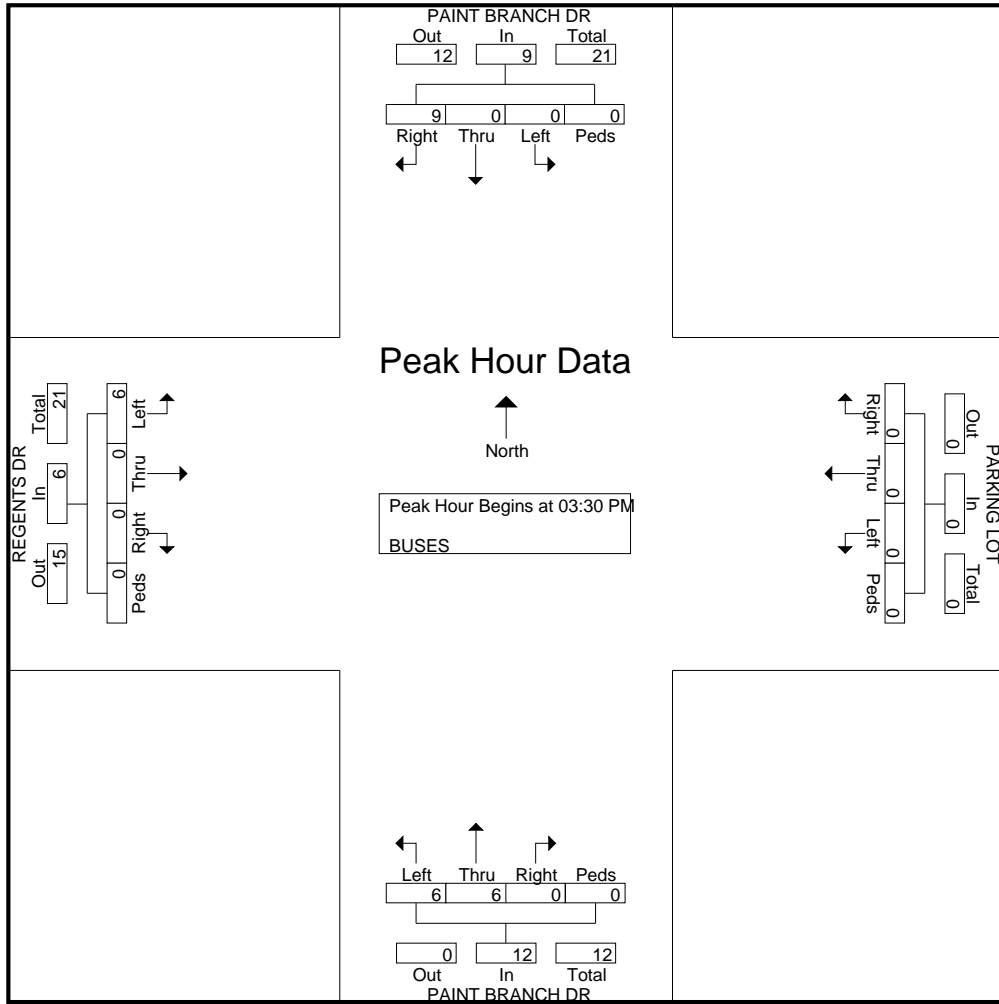

MEAD & HUNT

7055 Samuel Morse Dr. Ste. 100
Columbia, Maryland 21046
443-741-3500

Weather:
Counted By:
Town:
Country

File Name : regents dr at paint branch dr
Site Code : 00000000
Start Date : 9/19/2023
Page No : 1

Groups Printed- U TURNS

Start Time	PAINT BRANCH DR From North					PARKING LOT From East					PAINT BRANCH DR From South					REGENTS DR From West					Int. Total					
	Left	Thru	Right	Peds	App. Total	Left	Thru	Right	Peds	App. Total	Left	Thru	Right	Peds	App. Total	Left	Thru	Right	Peds	App. Total						
*** BREAK ***																										
08:45 AM	0	0	0	0	0	0	0	0	0	0	1	0	0	0	1	0	0	0	0	0	0	0	0	0	0	1
Total	0	0	0	0	0	0	0	0	0	0	1	0	0	0	1	0	0	0	0	0	0	0	0	0	0	1
*** BREAK ***																										
Grand Total	0	0	0	0	0	0	0	0	0	0	1	0	0	0	1	0	0	0	0	0	0	0	0	0	0	1
Apprch %	0	0	0	0	0	0	0	0	0	0	100	0	0	0	0	0	0	0	0	0	0	0	0	0	0	
Total %	0	0	0	0	0	0	0	0	0	0	100	0	0	0	100	0	0	0	0	0	0	0	0	0	0	

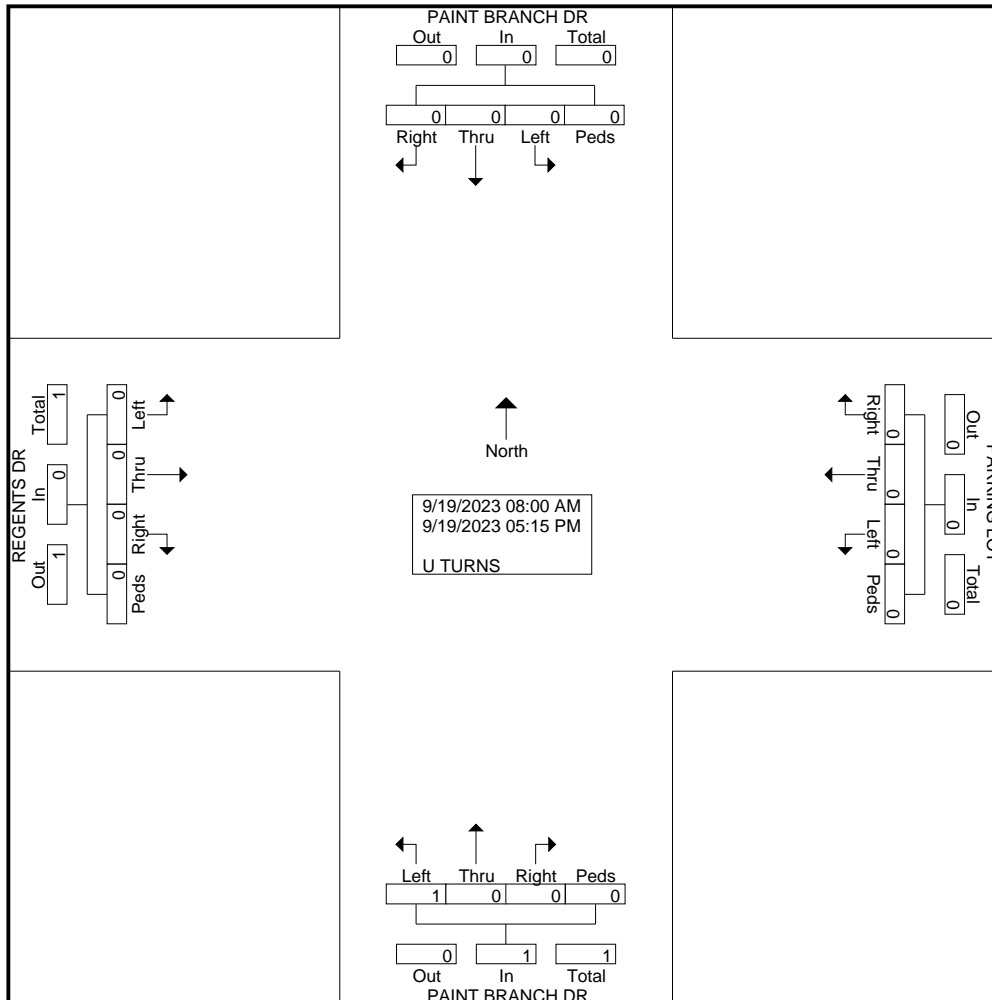

MEAD & HUNT

7055 Samuel Morse Dr. Ste. 100
Columbia, Maryland 21046

443-741-3500

Weather:
Counted By:
Town:
Country

File Name : stadium dr at regents dr
Site Code : 00000000
Start Date : 9/19/2023
Page No : 1

Groups Printed- VEHS&PEDS

Start Time	REGENTS DR From North					STADIUM DR From East					REGENTS DR From South					STADIUM DR From West					Int. Total
	Left	Thru	Right	Peds	App. Total	Left	Thru	Right	Peds	App. Total	Left	Thru	Right	Peds	App. Total	Left	Thru	Right	Peds	App. Total	
08:00 AM	1	17	22	29	69	5	0	2	46	53	20	18	1	44	83	1	1	6	24	32	237
08:15 AM	0	17	20	11	48	2	3	0	23	28	16	20	2	17	55	8	1	14	12	35	166
08:30 AM	0	20	26	20	66	0	0	0	36	36	17	10	1	40	68	6	0	16	15	37	207
08:45 AM	0	12	29	94	135	1	0	0	133	134	11	18	0	114	143	6	0	15	60	81	493
Total	1	66	97	154	318	8	3	2	238	251	64	66	4	215	349	21	2	51	111	185	1103
09:00 AM	1	31	26	78	136	0	1	1	88	90	15	15	1	34	65	4	1	19	39	63	354
09:15 AM	1	18	27	202	248	0	0	0	224	224	8	18	1	45	72	5	0	7	54	66	610
09:30 AM	0	30	52	93	175	0	0	0	110	110	11	26	1	20	58	6	0	9	33	48	391
09:45 AM	0	15	25	70	110	0	0	0	64	64	10	13	0	14	37	8	0	13	32	53	264
Total	2	94	130	443	669	0	1	1	486	488	44	72	3	113	232	23	1	48	158	230	1619
*** BREAK ***																					
03:30 PM	0	19	12	85	116	0	0	0	53	53	14	26	0	56	96	23	2	21	63	109	374
03:45 PM	0	22	14	110	146	1	1	0	78	80	19	18	0	73	110	13	0	17	76	106	442
Total	0	41	26	195	262	1	1	0	131	133	33	44	0	129	206	36	2	38	139	215	816
04:00 PM	0	22	14	88	124	0	0	0	45	45	25	25	0	49	99	20	0	29	34	83	351
04:15 PM	1	23	14	74	112	1	0	0	54	55	10	14	1	53	78	30	0	28	56	114	359
04:30 PM	0	18	16	67	101	0	0	0	52	52	12	23	0	38	73	29	0	20	27	76	302
04:45 PM	0	24	9	163	196	0	0	0	122	122	13	31	0	71	115	15	1	30	57	103	536
Total	1	87	53	392	533	1	0	0	273	274	60	93	1	211	365	94	1	107	174	376	1548
05:00 PM	0	26	19	95	140	0	0	0	79	79	19	22	0	53	94	33	0	31	55	119	432
05:15 PM	0	26	17	62	105	0	0	0	66	66	21	20	0	25	66	27	0	24	34	85	322
Grand Total	4	340	342	1341	2027	10	5	3	1273	1291	241	317	8	746	1312	234	6	299	671	1210	5840
Apprch %	0.2	16.8	16.9	66.2		0.8	0.4	0.2	98.6		18.4	24.2	0.6	56.9		19.3	0.5	24.7	55.5		
Total %	0.1	5.8	5.9	23	34.7	0.2	0.1	0.1	21.8	22.1	4.1	5.4	0.1	12.8	22.5	4	0.1	5.1	11.5	20.7	

MEAD & HUNT

7055 Samuel Morse Dr. Ste. 100
Columbia, Maryland 21046

443-741-3500

File Name : stadium dr at regents dr

Site Code : 00000000

Start Date : 9/19/2023

Page No : 2

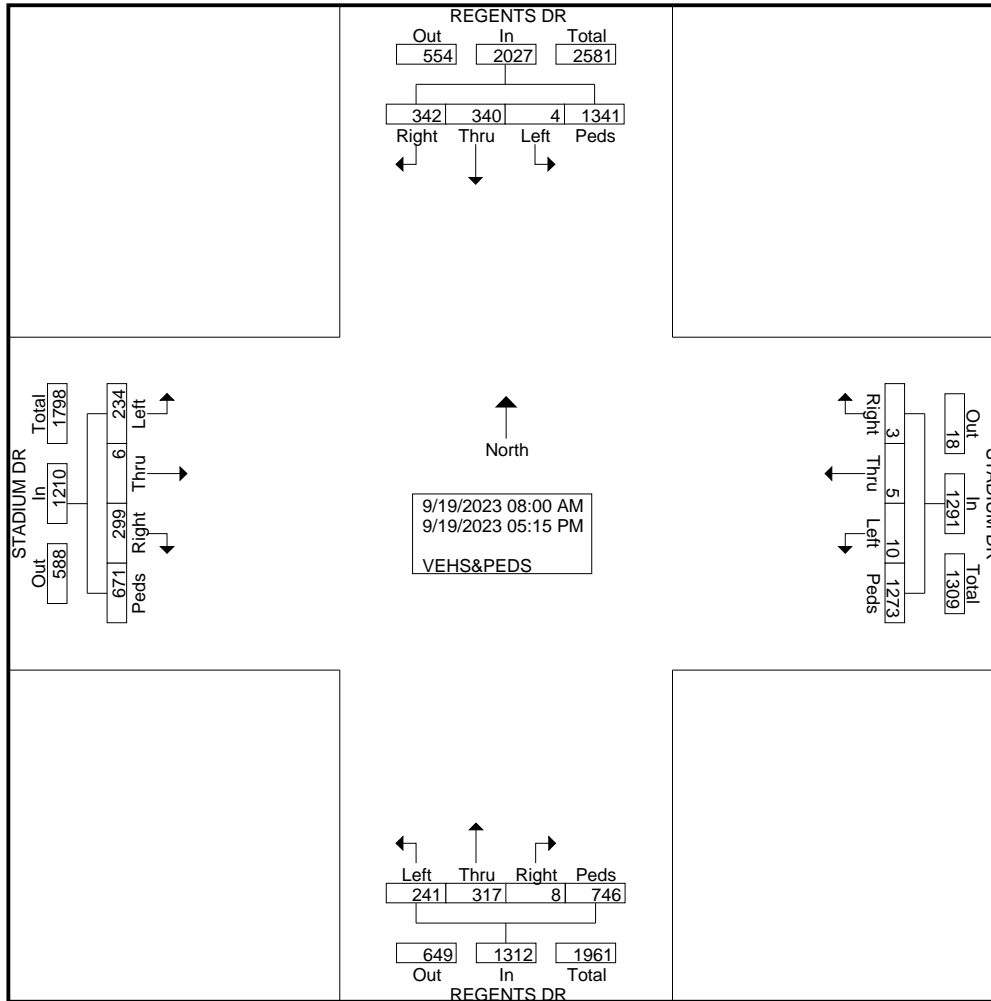

MEAD & HUNT

7055 Samuel Morse Dr. Ste. 100
Columbia, Maryland 21046
443-741-3500

File Name : stadium dr at regents dr
Site Code : 00000000
Start Date : 9/19/2023
Page No : 3

Start Time	REGENTS DR From North					STADIUM DR From East					REGENTS DR From South					STADIUM DR From West					Int. Total
	Left	Thru	Right	Peds	App. Total	Left	Thru	Right	Peds	App. Total	Left	Thru	Right	Peds	App. Total	Left	Thru	Right	Peds	App. Total	
Peak Hour Analysis From 08:00 AM to 12:45 PM - Peak 1 of 1																					
Peak Hour for Entire Intersection Begins at 08:45 AM																					
08:45 AM	0	12	29	94	135	1	0	0	133	134	11	18	0	114	143	6	0	15	60	81	493
09:00 AM	1	31	26	78	136	0	1	1	88	90	15	15	1	34	65	4	1	19	39	63	354
09:15 AM	1	18	27	202	248	0	0	0	224	224	8	18	1	45	72	5	0	7	54	66	610
09:30 AM	0	30	52	93	175	0	0	0	110	110	11	26	1	20	58	6	0	9	33	48	391
Total Volume	2	91	134	467	694	1	1	1	555	558	45	77	3	213	338	21	1	50	186	258	1848
% App. Total	0.3	13.1	19.3	67.3		0.2	0.2	0.2	99.5		13.3	22.8	0.9	63		8.1	0.4	19.4	72.1		
PHF	.500	.734	.644	.578	.700	.250	.250	.250	.619	.623	.750	.740	.750	.467	.591	.875	.250	.658	.775	.796	.757

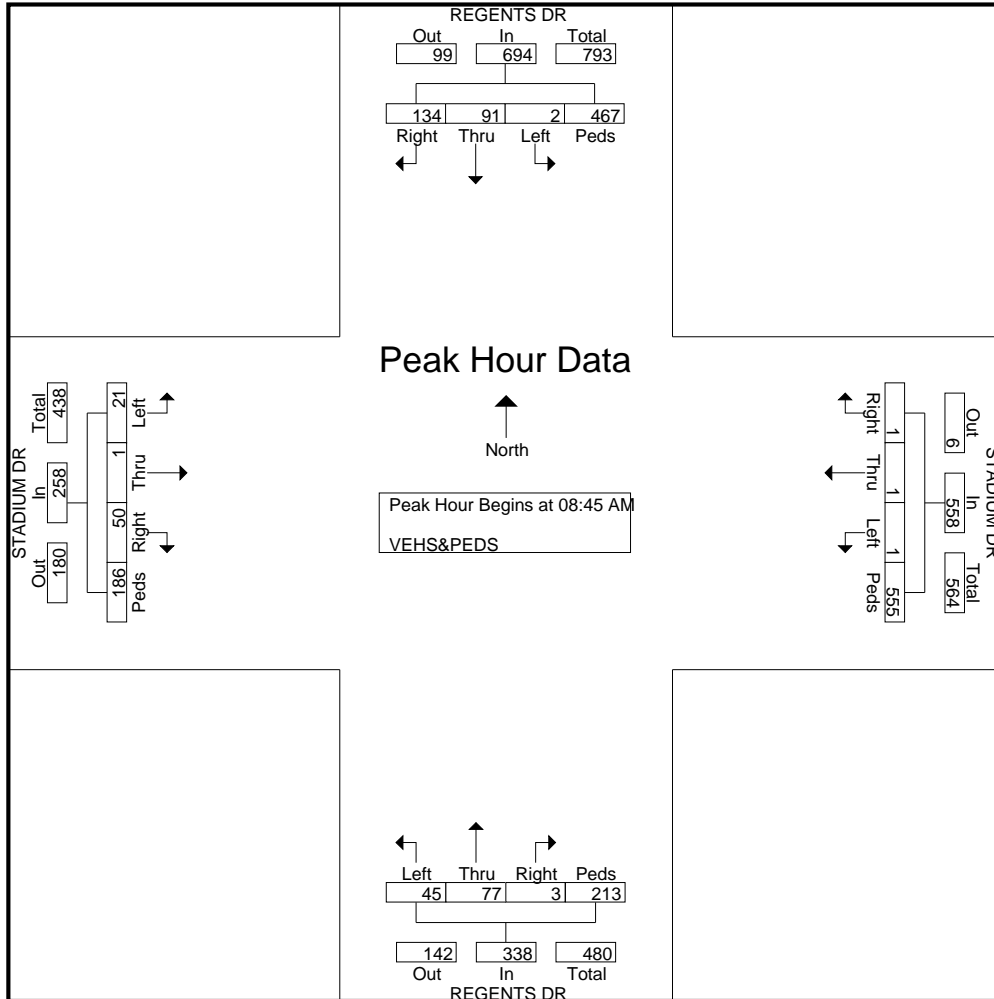

MEAD & HUNT

7055 Samuel Morse Dr. Ste. 100
Columbia, Maryland 21046
443-741-3500

File Name : stadium dr at regents dr
Site Code : 00000000
Start Date : 9/19/2023
Page No : 4

Start Time	REGENTS DR From North					STADIUM DR From East					REGENTS DR From South					STADIUM DR From West					Int. Total
	Left	Thru	Right	Peds	App. Total	Left	Thru	Right	Peds	App. Total	Left	Thru	Right	Peds	App. Total	Left	Thru	Right	Peds	App. Total	

Peak Hour Analysis From 01:00 PM to 05:15 PM - Peak 1 of 1

Peak Hour for Entire Intersection Begins at 04:15 PM

04:15 PM	1	23	14	74	112	1	0	0	54	55	10	14	1	53	78	30	0	28	56	114	359
04:30 PM	0	18	16	67	101	0	0	0	52	52	12	23	0	38	73	29	0	20	27	76	302
04:45 PM	0	24	9	163	196	0	0	0	122	122	13	31	0	71	115	15	1	30	57	103	536
05:00 PM	0	26	19	95	140	0	0	0	79	79	19	22	0	53	94	33	0	31	55	119	432
Total Volume	1	91	58	399	549	1	0	0	307	308	54	90	1	215	360	107	1	109	195	412	1629
% App. Total	0.2	16.6	10.6	72.7		0.3	0	0	99.7		15	25	0.3	59.7		26	0.2	26.5	47.3		
PHF	.250	.875	.763	.612	.700	.250	.000	.000	.629	.631	.711	.726	.250	.757	.783	.811	.250	.879	.855	.866	.760

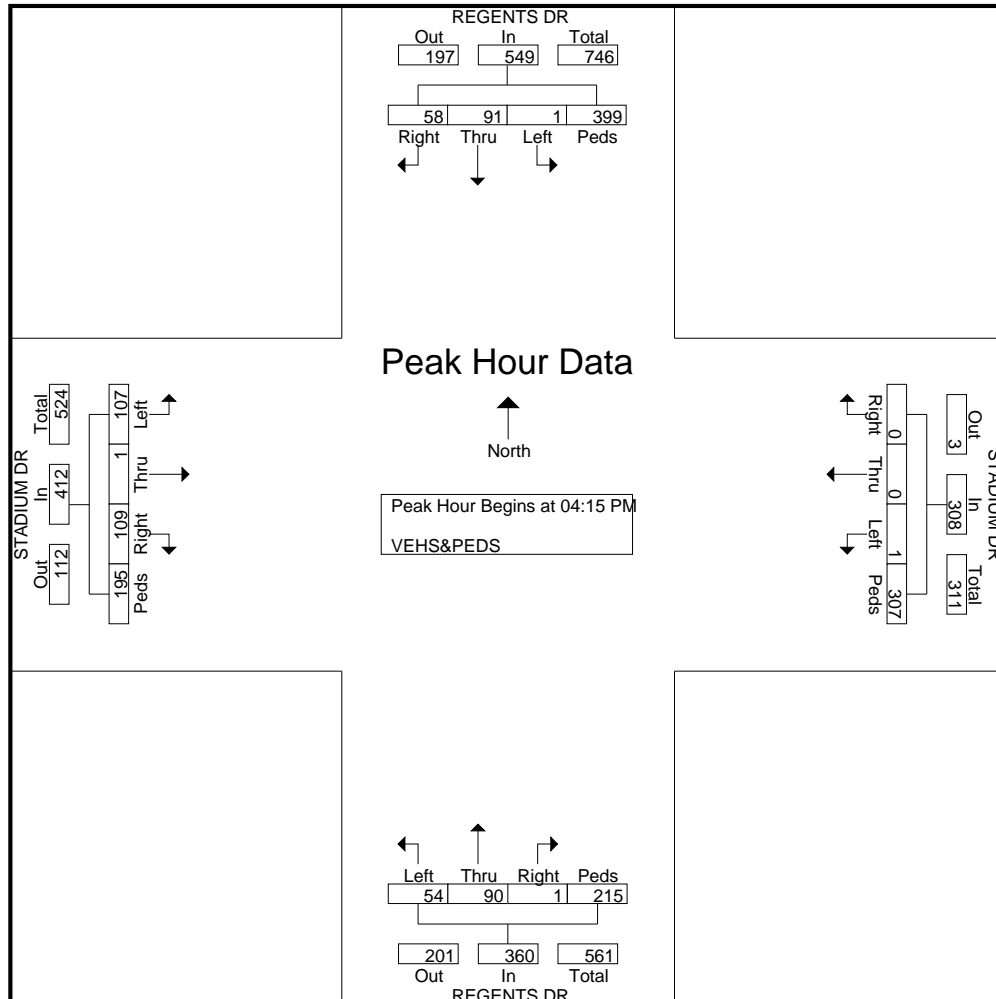

MEAD & HUNT

7055 Samuel Morse Dr. Ste. 100
Columbia, Maryland 21046
443-741-3500

Weather:
Counted By:
Town:
Country

File Name : stadium dr at regents dr
Site Code : 00000000
Start Date : 9/19/2023
Page No : 1

Groups Printed- BICYCLES

Start Time	REGENTS DR From North					STADIUM DR From East					REGENTS DR From South					STADIUM DR From West					Int. Total
	Left	Thru	Right	Peds	App. Total	Left	Thru	Right	Peds	App. Total	Left	Thru	Right	Peds	App. Total	Left	Thru	Right	Peds	App. Total	
08:00 AM	0	1	1	0	2	0	1	0	3	4	0	3	1	0	4	0	0	0	2	2	12
08:15 AM	0	2	1	0	3	0	0	0	2	2	2	1	0	1	4	0	0	0	3	3	12
08:30 AM	0	4	0	3	7	0	0	1	2	3	1	0	1	0	2	0	0	0	0	0	12
08:45 AM	0	7	1	2	10	0	1	0	1	2	2	2	1	2	7	1	0	0	1	2	21
Total	0	14	3	5	22	0	2	1	8	11	5	6	3	3	17	1	0	0	6	7	57
09:00 AM	0	3	0	0	3	0	0	0	2	2	0	8	0	0	8	0	0	0	0	0	13
09:15 AM	0	2	0	1	3	0	0	0	1	1	0	5	0	0	5	0	0	0	0	0	9
09:30 AM	0	1	0	0	1	0	0	0	3	3	0	4	0	0	4	0	0	0	0	0	8
09:45 AM	0	0	0	1	1	0	0	0	0	0	0	1	0	0	1	0	0	0	0	0	2
Total	0	6	0	2	8	0	0	0	6	6	0	18	0	0	18	0	0	0	0	0	32
*** BREAK ***																					
02:30 PM	0	0	0	0	0	0	0	0	0	0	0	0	0	0	0	0	0	0	1	1	1
*** BREAK ***																					
Total	0	0	0	0	0	0	0	0	0	0	0	0	0	0	0	0	0	0	1	1	1
03:00 PM	0	0	0	0	0	0	0	0	0	0	0	0	0	1	1	0	0	0	0	0	1
03:15 PM	0	0	0	0	0	0	0	0	0	0	0	0	0	4	4	0	0	0	0	0	4
03:30 PM	0	9	1	0	10	0	0	0	0	0	4	0	0	1	5	0	0	3	0	3	18
03:45 PM	0	4	2	0	6	0	0	0	0	0	0	1	0	0	1	0	0	1	1	2	9
Total	0	13	3	0	16	0	0	0	0	0	4	1	0	6	11	0	0	4	1	5	32
04:00 PM	0	2	0	0	2	0	0	1	0	1	0	0	0	0	0	0	0	0	0	0	3
04:15 PM	0	4	1	0	5	0	0	0	2	2	1	0	0	2	3	0	0	1	0	1	11
04:30 PM	0	3	0	0	3	0	1	1	0	2	0	9	2	0	11	2	0	0	0	2	18
04:45 PM	0	1	0	0	1	0	2	0	0	2	0	17	4	0	21	1	0	0	0	1	25
Total	0	10	1	0	11	0	3	2	2	7	1	26	6	2	35	3	0	1	0	4	57
05:00 PM	0	0	0	0	0	0	1	0	0	1	0	9	0	0	9	1	0	0	0	1	11
05:15 PM	0	1	0	0	1	0	2	0	0	2	0	10	0	0	10	1	0	0	0	1	14
Grand Total	0	44	7	7	58	0	8	3	16	27	10	70	9	11	100	6	0	5	8	19	204
Apprch %	0	75.9	12.1	12.1		0	29.6	11.1	59.3		10	70	9	11		31.6	0	26.3	42.1		
Total %	0	21.6	3.4	3.4	28.4	0	3.9	1.5	7.8	13.2	4.9	34.3	4.4	5.4	49	2.9	0	2.5	3.9	9.3	

MEAD & HUNT

7055 Samuel Morse Dr. Ste. 100
 Columbia, Maryland 21046
 443-741-3500

File Name : stadium dr at regents dr
 Site Code : 00000000
 Start Date : 9/19/2023
 Page No : 2

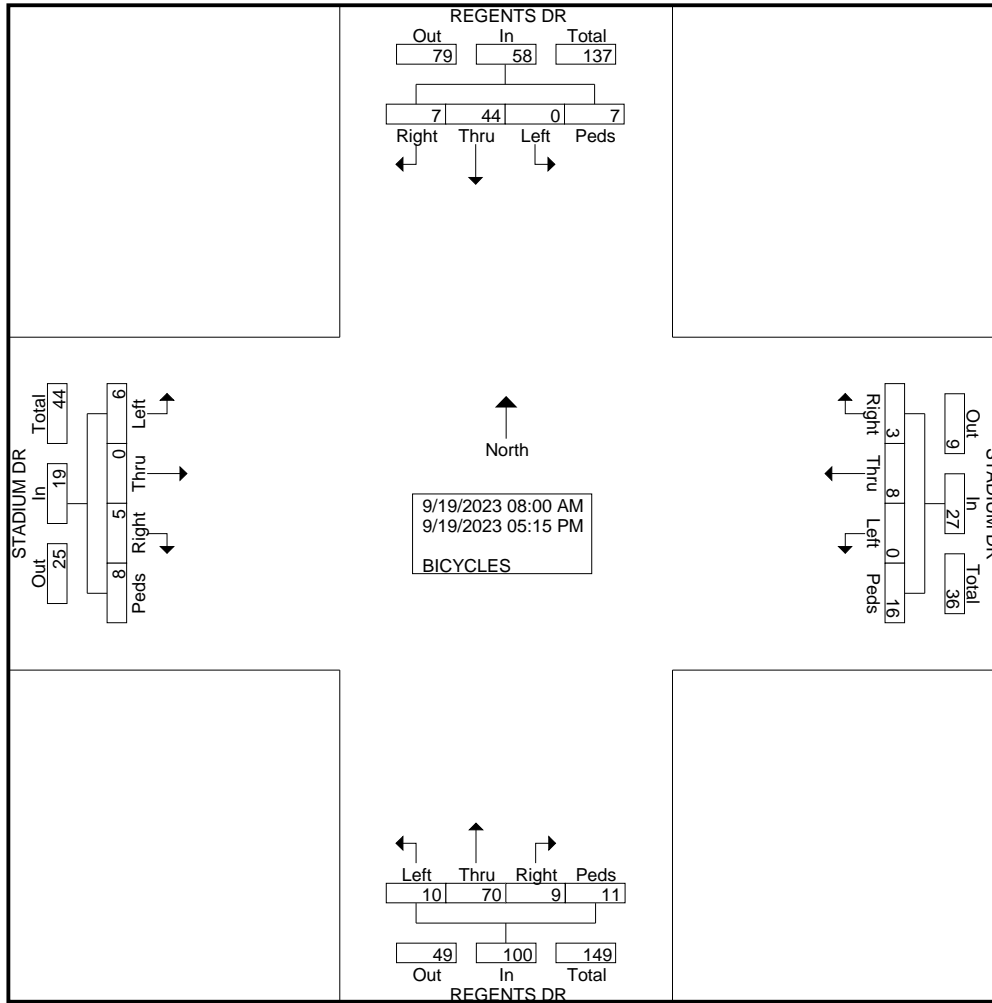

MEAD & HUNT

7055 Samuel Morse Dr. Ste. 100
Columbia, Maryland 21046
443-741-3500

Weather:
Counted By:
Town:
Country

File Name : stadium dr at regents dr
Site Code : 00000000
Start Date : 9/19/2023
Page No : 1

Groups Printed- SCOOTERS

Start Time	REGENTS DR From North					STADIUM DR From East					REGENTS DR From South					STADIUM DR From West					Int. Total	
	Left	Thru	Right	Peds	App. Total	Left	Thru	Right	Peds	App. Total	Left	Thru	Right	Peds	App. Total	Left	Thru	Right	Peds	App. Total		
08:00 AM	0	6	0	0	6	0	0	0	0	0	0	5	0	0	5	0	0	0	0	0	0	11
08:15 AM	0	5	0	0	5	0	0	1	0	1	2	4	1	0	7	2	0	0	0	2	0	15
08:30 AM	0	6	0	0	6	0	0	0	0	0	1	3	0	0	4	0	0	0	0	0	0	10
08:45 AM	0	3	0	0	3	0	2	0	0	2	0	3	0	0	3	0	0	0	0	0	0	8
Total	0	20	0	0	20	0	2	1	0	3	3	15	1	0	19	2	0	0	0	2	0	44
09:00 AM	0	0	0	0	0	0	0	0	0	0	0	0	0	0	0	1	0	0	0	1	0	1
09:15 AM	0	3	0	0	3	0	0	0	0	0	0	0	0	0	0	0	0	0	0	0	0	3
09:30 AM	0	0	0	0	0	0	0	0	0	0	0	3	0	0	3	0	0	0	0	0	0	3
09:45 AM	0	0	0	0	0	0	0	0	0	0	0	3	0	0	3	0	0	0	0	0	0	3
Total	0	3	0	0	3	0	0	0	0	0	0	6	0	0	6	1	0	0	0	1	0	10
*** BREAK ***																						
03:30 PM	0	2	0	0	2	0	0	0	0	0	9	0	0	0	9	0	0	1	0	1	0	12
03:45 PM	0	5	2	0	7	0	0	0	0	0	3	0	0	0	3	0	0	1	0	1	0	11
Total	0	7	2	0	9	0	0	0	0	0	12	0	0	0	12	0	0	2	0	2	0	23
04:00 PM	0	2	2	0	4	0	0	1	0	1	5	1	0	0	6	0	0	0	0	0	0	11
04:15 PM	0	3	0	0	3	0	0	0	0	0	2	2	0	0	4	0	0	0	0	0	0	7
04:30 PM	0	3	0	0	3	0	1	0	0	1	1	7	3	0	11	2	0	0	0	2	0	17
04:45 PM	0	3	0	0	3	0	2	1	0	3	0	15	4	0	19	0	0	0	0	0	0	25
Total	0	11	2	0	13	0	3	2	0	5	8	25	7	0	40	2	0	0	0	2	0	60
05:00 PM	0	0	0	0	0	0	2	0	0	2	0	11	0	0	11	0	0	0	0	0	0	13
05:15 PM	1	0	0	0	1	0	0	0	0	0	0	7	1	0	8	0	0	0	0	0	0	9
Grand Total	1	41	4	0	46	0	7	3	0	10	23	64	9	0	96	5	0	2	0	7	0	159
Apprch %	2.2	89.1	8.7	0		0	70	30	0		24	66.7	9.4	0		71.4	0	28.6	0			
Total %	0.6	25.8	2.5	0	28.9	0	4.4	1.9	0	6.3	14.5	40.3	5.7	0	60.4	3.1	0	1.3	0	4.4		

MEAD & HUNT

7055 Samuel Morse Dr. Ste. 100
Columbia, Maryland 21046

443-741-3500

File Name : stadium dr at regents dr

Site Code : 00000000

Start Date : 9/19/2023

Page No : 2

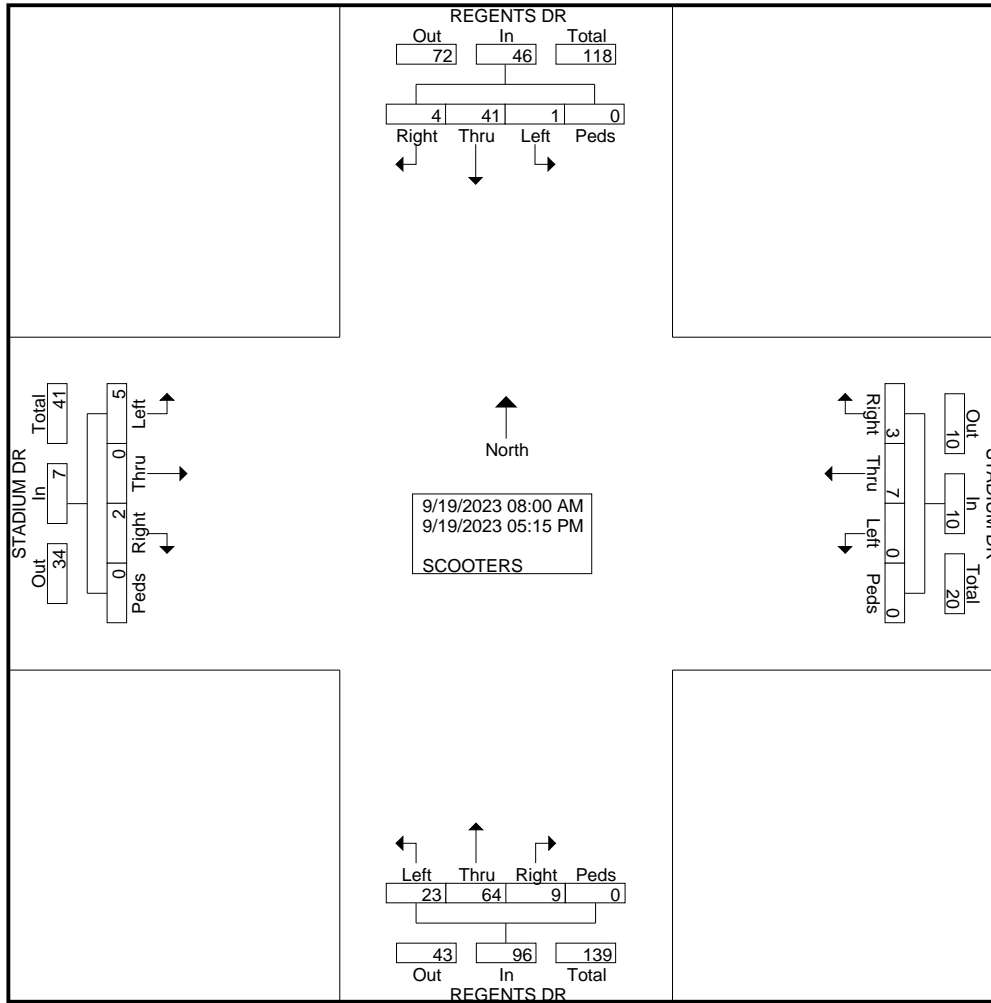

MEAD & HUNT

7055 Samuel Morse Dr. Ste. 100

Columbia, Maryland 21046

443-741-3500

Weather:
 Counted By:
 Town:
 Country

File Name : stadium dr at regents dr
 Site Code : 00000000
 Start Date : 9/19/2023
 Page No : 1

Groups Printed- SKATEBOARDS

Start Time	REGENTS DR From North					STADIUM DR From East					REGENTS DR From South					STADIUM DR From West					Int. Total	
	Left	Thru	Right	Peds	App. Total	Left	Thru	Right	Peds	App. Total	Left	Thru	Right	Peds	App. Total	Left	Thru	Right	Peds	App. Total		
*** BREAK ***																						
09:15 AM	0	0	0	1	1	0	0	0	0	0	0	0	0	0	0	0	0	0	0	0	0	1
*** BREAK ***																						
Total	0	0	0	1	1	0	0	0	0	0	0	0	0	0	0	0	0	0	0	0	0	1
*** BREAK ***																						
04:30 PM	0	0	0	1	1	0	0	0	0	0	0	0	0	0	0	0	0	0	1	1	0	2
04:45 PM	0	0	0	1	1	0	0	0	0	0	0	0	0	0	0	0	0	0	0	0	0	1
Total	0	0	0	2	2	0	0	0	0	0	0	0	0	0	0	0	0	0	1	1	0	3
*** BREAK ***																						
05:15 PM	0	0	0	1	1	0	0	0	0	0	0	0	0	0	0	0	0	0	0	0	0	1
Grand Total	0	0	0	4	4	0	0	0	0	0	0	0	0	0	0	0	0	0	1	1	0	5
Apprch %	0	0	0	100		0	0	0	0		0	0	0	0		0	0	0	100		0	
Total %	0	0	0	80	80	0	0	0	0	0	0	0	0	0	0	0	0	0	20	20	0	

MEAD & HUNT

7055 Samuel Morse Dr. Ste. 100
Columbia, Maryland 21046

443-741-3500

File Name : stadium dr at regents dr

Site Code : 00000000

Start Date : 9/19/2023

Page No : 2

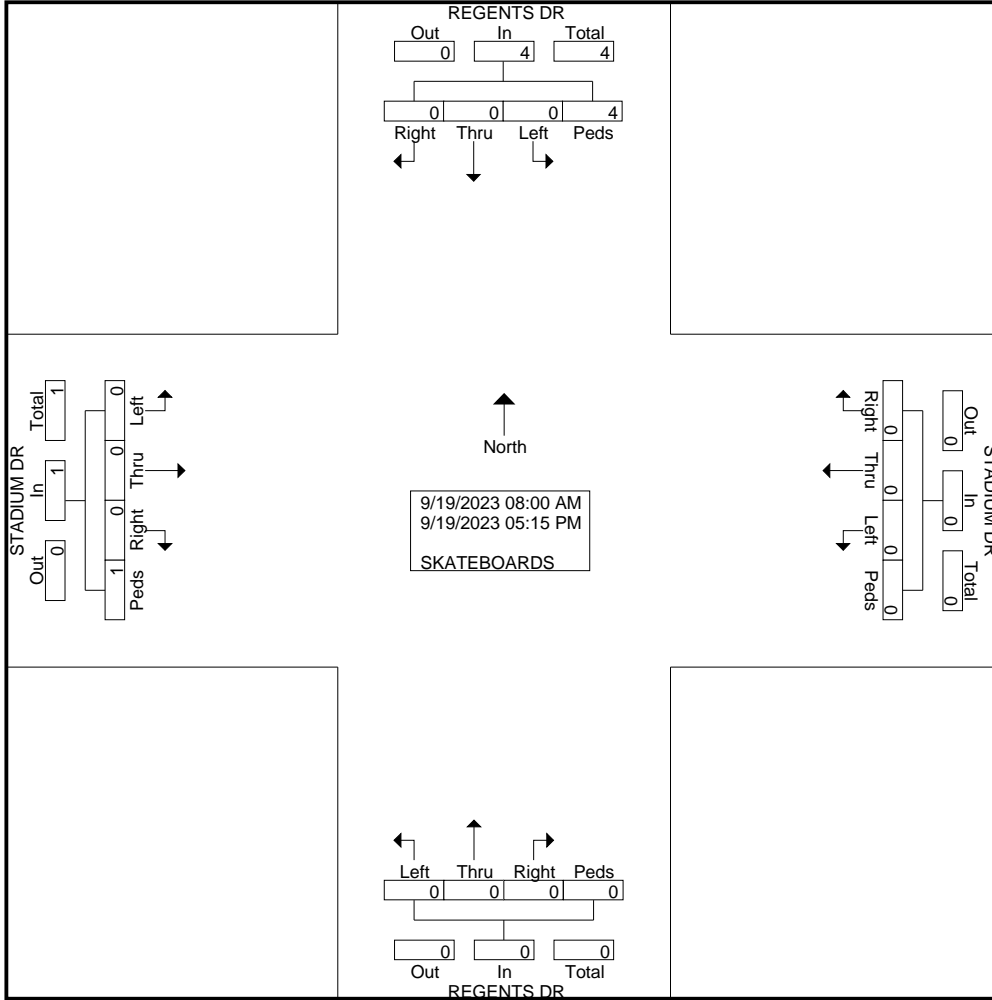

MEAD & HUNT

7055 Samuel Morse Dr. Ste. 100

Columbia, Maryland 21046

443-741-3500

Weather:
Counted By:
Town:
Country

File Name : stadium dr at regents dr
Site Code : 00000000
Start Date : 9/19/2023
Page No : 1

Groups Printed- BUSES

Start Time	REGENTS DR From North					STADIUM DR From East					REGENTS DR From South					STADIUM DR From West					Int. Total
	Left	Thru	Right	Peds	App. Total	Left	Thru	Right	Peds	App. Total	Left	Thru	Right	Peds	App. Total	Left	Thru	Right	Peds	App. Total	
08:00 AM	0	4	0	0	4	0	0	0	0	0	1	1	0	0	2	0	0	2	0	2	8
08:15 AM	0	4	0	0	4	0	0	0	0	0	3	1	0	0	4	0	0	1	0	1	9
08:30 AM	0	4	0	0	4	0	0	0	0	0	0	1	0	0	1	0	0	2	0	2	7
08:45 AM	0	3	0	0	3	0	0	0	0	0	3	2	0	0	5	0	0	3	0	3	11
Total	0	15	0	0	15	0	0	0	0	0	7	5	0	0	12	0	0	8	0	8	35
09:00 AM	0	4	0	0	4	0	0	0	0	0	1	1	0	0	2	0	0	1	0	1	7
09:15 AM	0	3	0	0	3	0	0	0	0	0	1	0	0	0	1	0	0	2	0	2	6
09:30 AM	0	5	0	0	5	0	0	0	0	0	2	1	0	0	3	0	0	3	0	3	11
09:45 AM	0	3	0	0	3	0	0	0	0	0	1	3	0	0	4	1	0	2	0	3	10
Total	0	15	0	0	15	0	0	0	0	0	5	5	0	0	10	1	0	8	0	9	34
*** BREAK ***																					
03:30 PM	0	1	0	0	1	0	0	0	1	1	1	1	0	0	2	0	0	2	0	2	6
03:45 PM	0	6	0	0	6	0	0	0	0	0	2	1	0	0	3	0	0	2	0	2	11
Total	0	7	0	0	7	0	0	0	1	1	3	2	0	0	5	0	0	4	0	4	17
04:00 PM	0	2	0	0	2	0	0	0	0	0	2	2	0	0	4	0	0	4	0	4	10
04:15 PM	0	5	0	0	5	0	0	0	0	0	2	1	0	0	3	0	0	3	0	3	11
04:30 PM	0	3	0	0	3	0	0	0	0	0	0	1	0	0	1	0	0	1	0	1	5
04:45 PM	0	4	0	0	4	0	0	0	0	0	4	2	0	0	6	0	0	2	0	2	12
Total	0	14	0	0	14	0	0	0	0	0	8	6	0	0	14	0	0	10	0	10	38
05:00 PM	0	3	0	0	3	0	0	0	0	0	2	0	0	0	2	0	0	4	0	4	9
05:15 PM	0	4	0	0	4	0	0	0	0	0	1	2	0	0	3	0	0	5	0	5	12
Grand Total	0	58	0	0	58	0	0	0	1	1	26	20	0	0	46	1	0	39	0	40	145
Apprch %	0	100	0	0		0	0	0	100		56.5	43.5	0	0		2.5	0	97.5	0		
Total %	0	40	0	0	40	0	0	0	0.7	0.7	17.9	13.8	0	0	31.7	0.7	0	26.9	0	27.6	

MEAD & HUNT

7055 Samuel Morse Dr. Ste. 100
Columbia, Maryland 21046

443-741-3500

File Name : stadium dr at regents dr

Site Code : 00000000

Start Date : 9/19/2023

Page No : 2

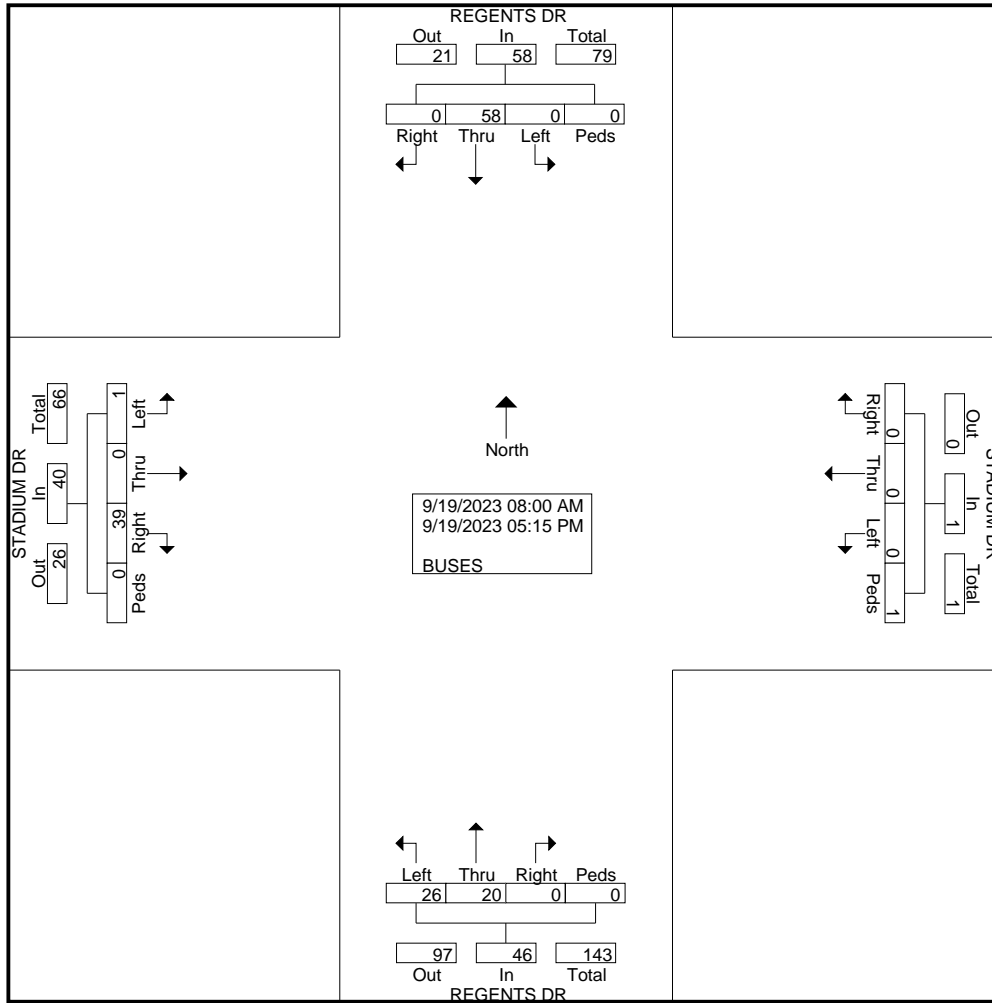

MEAD & HUNT

7055 Samuel Morse Dr. Ste. 100
Columbia, Maryland 21046

443-741-3500

File Name : stadium dr at regents dr

Site Code : 00000000

Start Date : 9/19/2023

Page No : 3

Start Time	REGENTS DR From North					STADIUM DR From East					REGENTS DR From South					STADIUM DR From West					Int. Total
	Left	Thru	Right	Peds	App. Total	Left	Thru	Right	Peds	App. Total	Left	Thru	Right	Peds	App. Total	Left	Thru	Right	Peds	App. Total	
Peak Hour Analysis From 08:00 AM to 12:45 PM - Peak 1 of 1																					
Peak Hour for Entire Intersection Begins at 08:00 AM																					
08:00 AM	0	4	0	0	4	0	0	0	0	0	1	1	0	0	2	0	0	2	0	2	8
08:15 AM	0	4	0	0	4	0	0	0	0	0	3	1	0	0	4	0	0	1	0	1	9
08:30 AM	0	4	0	0	4	0	0	0	0	0	0	1	0	0	1	0	0	2	0	2	7
08:45 AM	0	3	0	0	3	0	0	0	0	0	3	2	0	0	5	0	0	3	0	3	11
Total Volume	0	15	0	0	15	0	0	0	0	0	7	5	0	0	12	0	0	8	0	8	35
% App. Total	0	100	0	0		0	0	0	0		58.3	41.7	0	0		0	0	100	0		
PHF	.000	.938	.000	.000	.938	.000	.000	.000	.000	.000	.583	.625	.000	.000	.600	.000	.000	.667	.000	.667	.795

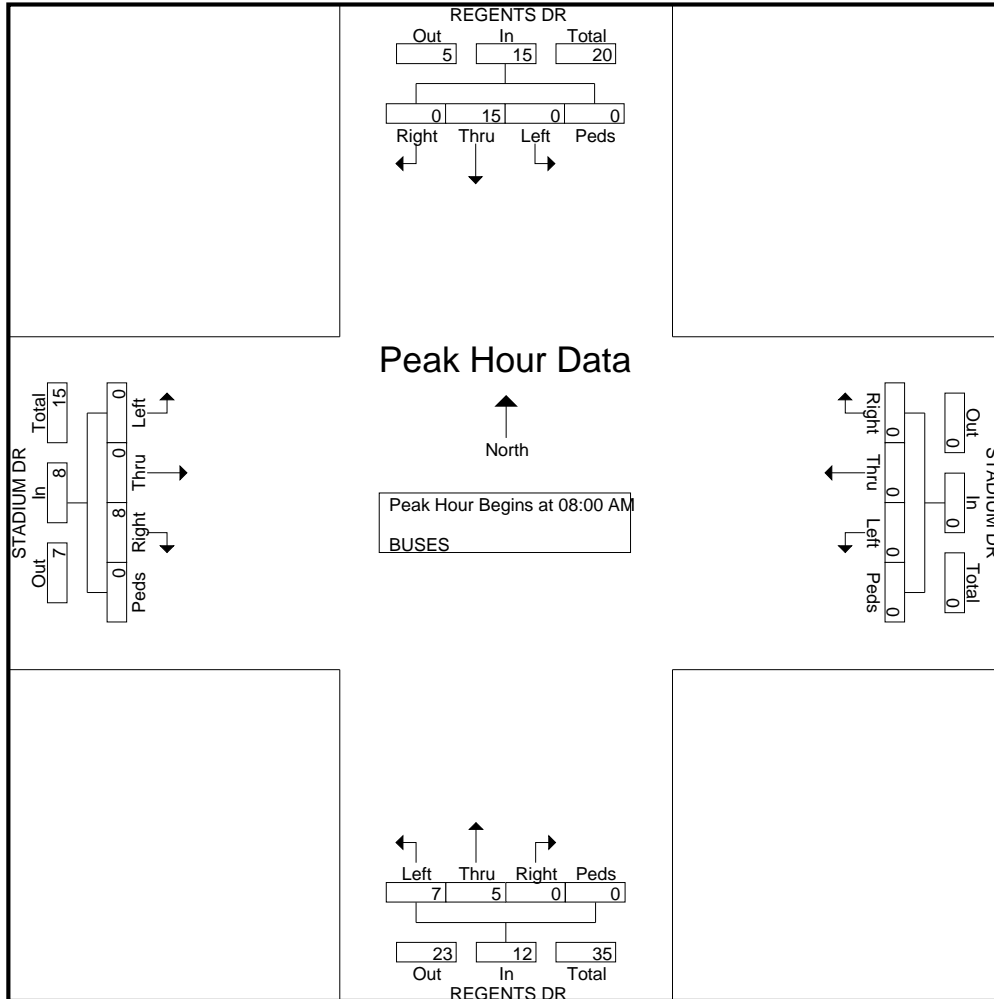

MEAD & HUNT

7055 Samuel Morse Dr. Ste. 100
Columbia, Maryland 21046
443-741-3500

File Name : stadium dr at regents dr
Site Code : 00000000
Start Date : 9/19/2023
Page No : 4

Start Time	REGENTS DR From North					STADIUM DR From East					REGENTS DR From South					STADIUM DR From West					Int. Total
	Left	Thru	Right	Peds	App. Total	Left	Thru	Right	Peds	App. Total	Left	Thru	Right	Peds	App. Total	Left	Thru	Right	Peds	App. Total	
Peak Hour Analysis From 01:00 PM to 05:15 PM - Peak 1 of 1																					
Peak Hour for Entire Intersection Begins at 03:30 PM																					
03:30 PM	0	1	0	0	1	0	0	0	1	1	1	1	0	0	2	0	0	2	0	2	6
03:45 PM	0	6	0	0	6	0	0	0	0	0	2	1	0	0	3	0	0	2	0	2	11
04:00 PM	0	2	0	0	2	0	0	0	0	0	2	2	0	0	4	0	0	4	0	4	10
04:15 PM	0	5	0	0	5	0	0	0	0	0	2	1	0	0	3	0	0	3	0	3	11
Total Volume	0	14	0	0	14	0	0	0	1	1	7	5	0	0	12	0	0	11	0	11	38
% App. Total	0	100	0	0		0	0	0	100		58.3	41.7	0	0		0	0	100	0		
PHF	.000	.583	.000	.000	.583	.000	.000	.000	.250	.250	.875	.625	.000	.000	.750	.000	.000	.688	.000	.688	.864

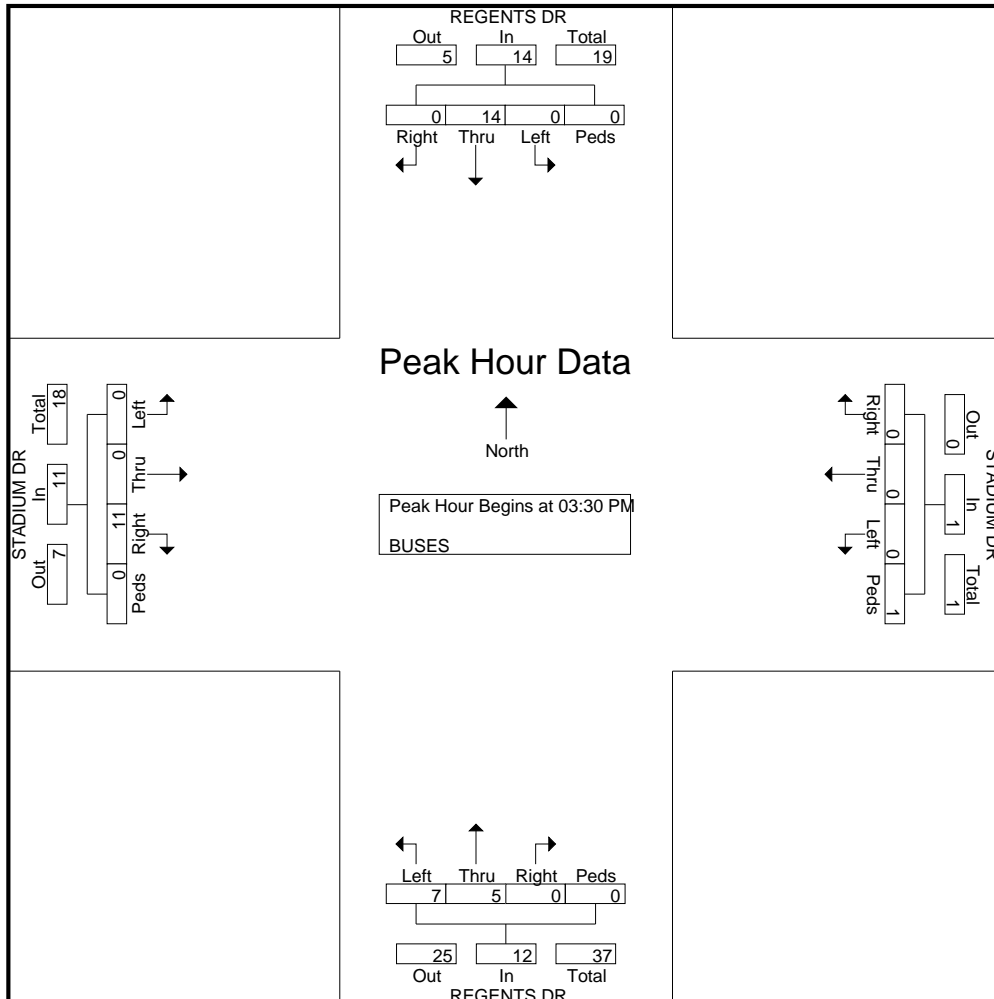

MEAD & HUNT

7055 Samuel Morse Dr. Ste. 100
Columbia, Maryland 21046
443-741-3500

Weather:
Counted By:
Town:
Country

File Name : stadium dr at regents dr
Site Code : 00000000
Start Date : 9/19/2023
Page No : 1

Groups Printed- U TURNS

Start Time	REGENTS DR From North					STADIUM DR From East					REGENTS DR From South					STADIUM DR From West					Int. Total
	Left	Thru	Right	Peds	App. Total	Left	Thru	Right	Peds	App. Total	Left	Thru	Right	Peds	App. Total	Left	Thru	Right	Peds	App. Total	
08:00 AM	0	0	0	0	0	1	0	0	0	1	0	0	0	0	0	0	0	0	0	0	1
*** BREAK ***																					
08:30 AM	0	0	0	0	0	0	0	0	0	0	0	0	0	0	0	1	0	0	0	1	1
08:45 AM	0	0	0	0	0	0	0	0	0	0	1	0	0	0	1	0	0	0	0	0	1
Total	0	0	0	0	0	1	0	0	0	1	1	0	0	0	1	1	0	0	0	1	3
*** BREAK ***																					
09:15 AM	1	0	0	0	1	0	0	0	0	0	0	0	0	0	0	0	0	0	0	0	1
*** BREAK ***																					
09:45 AM	0	0	0	0	0	0	0	0	0	0	1	0	0	0	1	0	0	0	0	0	1
Total	1	0	0	0	1	0	0	0	0	0	1	0	0	0	1	0	0	0	0	0	2
*** BREAK ***																					
03:30 PM	0	0	0	0	0	1	0	0	0	1	1	0	0	0	1	0	0	0	0	0	2
*** BREAK ***																					
Total	0	0	0	0	0	1	0	0	0	1	1	0	0	0	1	0	0	0	0	0	2
*** BREAK ***																					
04:30 PM	0	0	0	0	0	0	0	0	0	0	0	0	0	0	0	2	0	0	0	2	2
04:45 PM	1	0	0	0	1	0	0	0	0	0	0	0	0	0	0	0	0	0	0	0	1
Total	1	0	0	0	1	0	0	0	0	0	0	0	0	0	0	2	0	0	0	2	3
*** BREAK ***																					
Grand Total	2	0	0	0	2	2	0	0	0	2	3	0	0	0	3	3	0	0	0	3	10
Apprch %	100	0	0	0		100	0	0	0		100	0	0	0		100	0	0	0		
Total %	20	0	0	0	20	20	0	0	0	20	30	0	0	0	30	30	0	0	0	30	

MEAD & HUNT

7055 Samuel Morse Dr. Ste. 100
Columbia, Maryland 21046

443-741-3500

File Name : stadium dr at regents dr

Site Code : 00000000

Start Date : 9/19/2023

Page No : 2

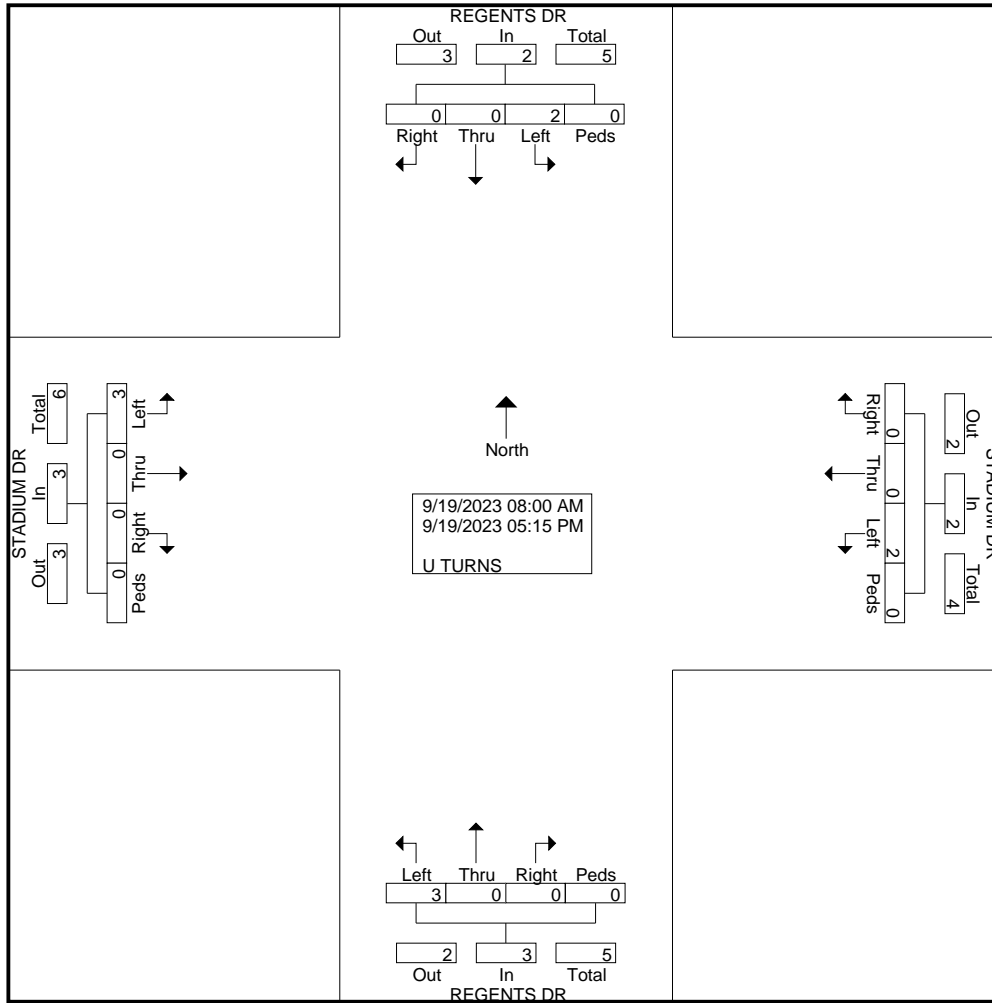

7 Traffic Count Locations

1. Mowatt Ln at Campus Drive
2. Paint Branch Drive at Campus Drive
3. Preinkert Drive at Campus Drive
4. Regents Drive at Baltimore Ave (US1)
5. Regents Drive at Campus Drive
6. Regents Drive at Paint Branch Drive
7. Stadium Drive at Regents Drive

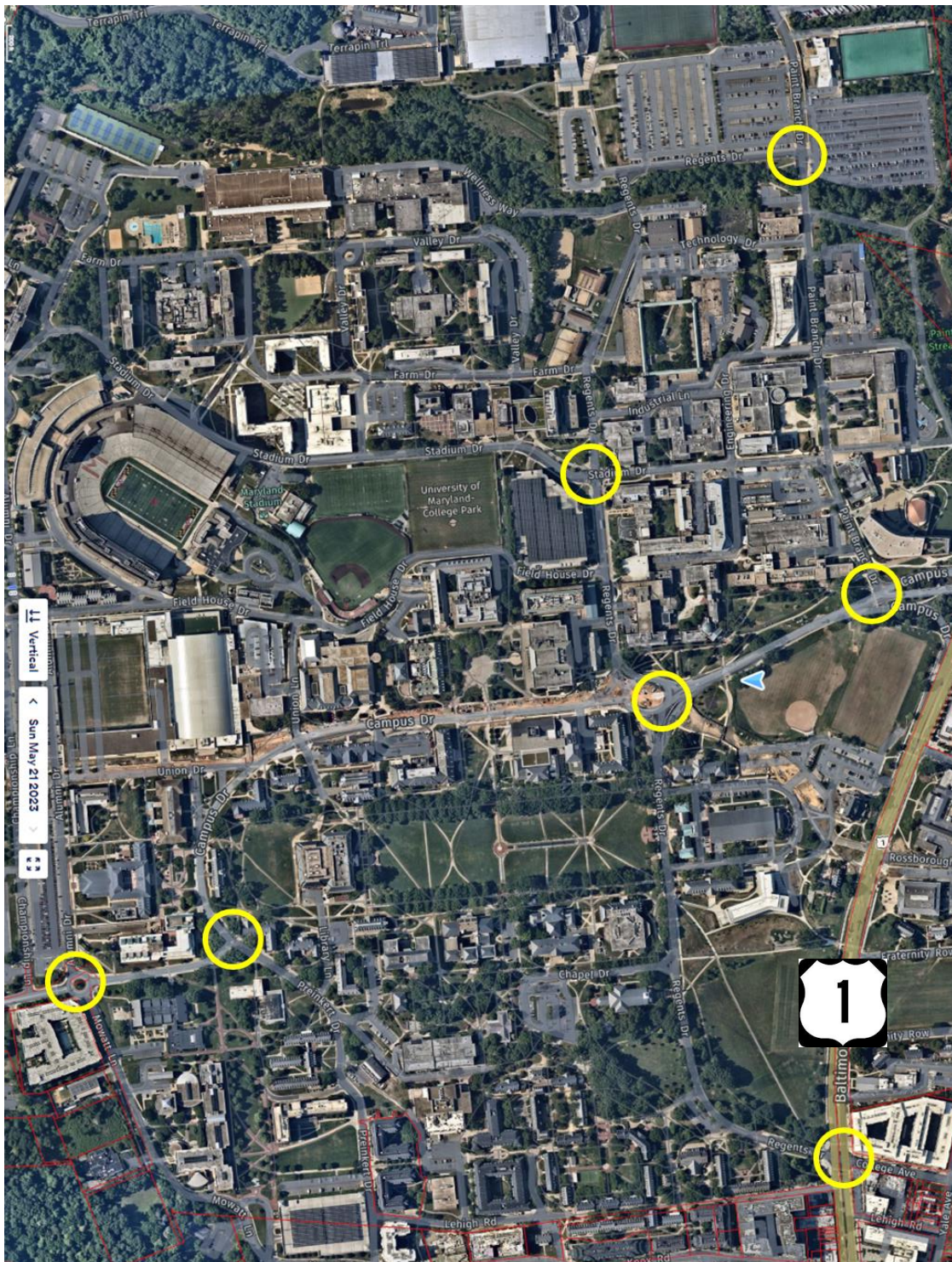

1. Mowatt Ln at Campus Drive

AM Peak Hour				
Cars	Pedestrians	Bikes	Scooters	Skateboards
1138	371	52	43	0
70.9%	23.1%	3.2%	2.7%	0.0%

PM Peak Hour				
Cars	Pedestrians	Bikes	Scooters	Skateboards
1090	332	41	46	0
72.2%	20.7%	2.6%	2.9%	0.0%

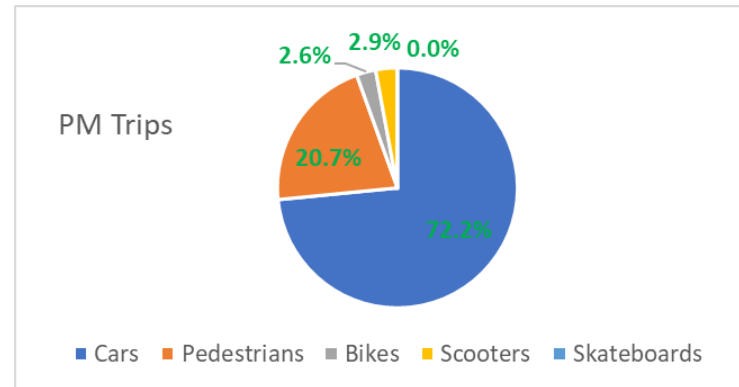
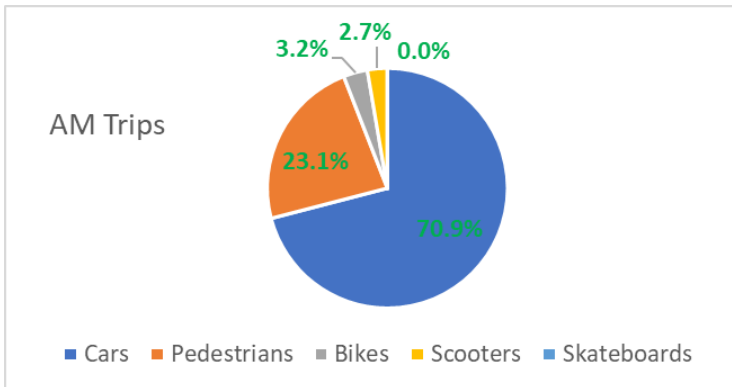

2. Paint Branch Drive at Campus Drive

AM Peak Hour				
Cars	Pedestrians	Bikes	Scooters	Skateboards
849	140	50	7	4
80.9%	13.3%	4.8%	0.7%	0.4%

PM Peak Hour				
Cars	Pedestrians	Bikes	Scooters	Skateboards
819	174	38	19	2
77.9%	16.6%	3.6%	1.8%	0.2%

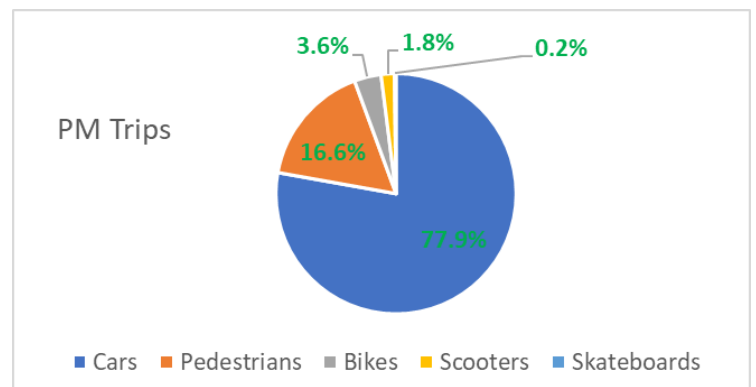
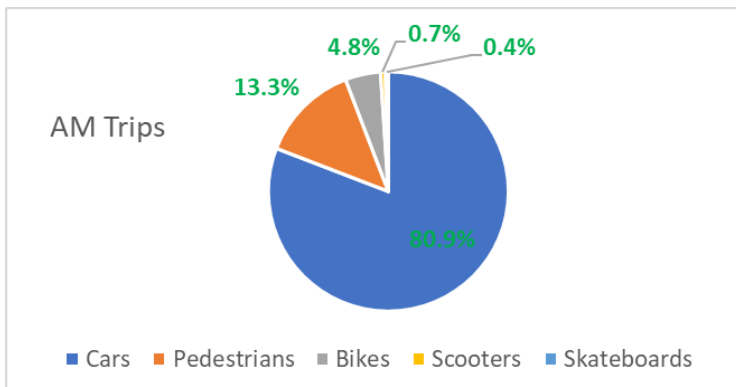

3. Preinkert Drive at Campus Drive

AM Peak Hour				
Cars	Pedestrians	Bikes	Scooters	Skateboards
266	240	26	35	0
46.9%	42.3%	4.6%	6.2%	0.0%

PM Peak Hour				
Cars	Pedestrians	Bikes	Scooters	Skateboards
237	213	28	34	1
46.2%	37.6%	4.9%	6.0%	0.2%

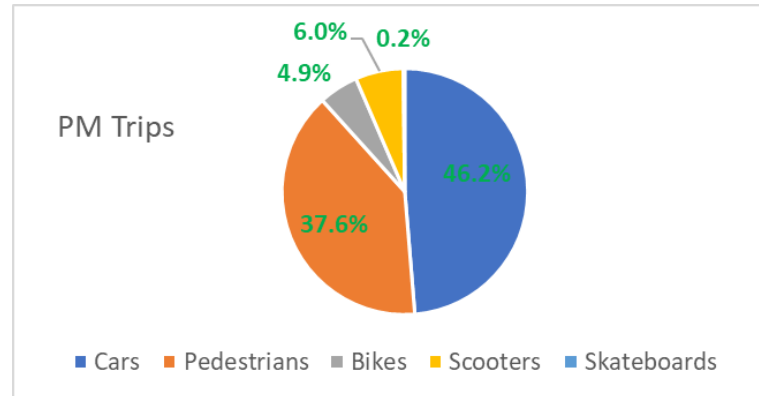
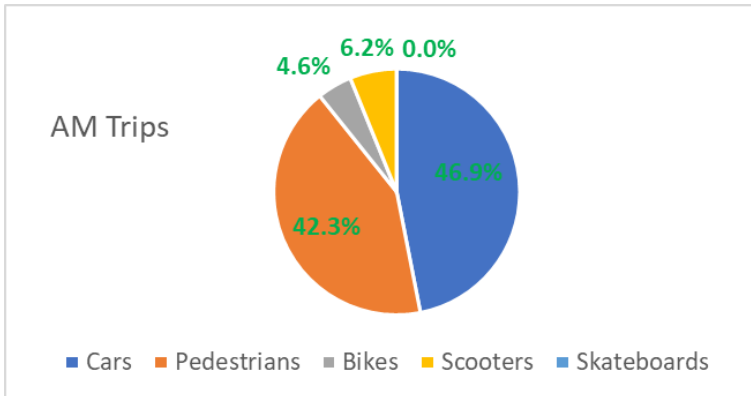

4. Regents Drive at Baltimore Ave (US1)

AM Peak Hour				
Cars	Pedestrians	Bikes	Scooters	Skateboards
1469	639	62	8	3
67.4%	29.3%	2.8%	0.4%	0.1%

PM Peak Hour				
Cars	Pedestrians	Bikes	Scooters	Skateboards
1803	568	59	14	2
73.7%	26.0%	2.7%	0.6%	0.1%

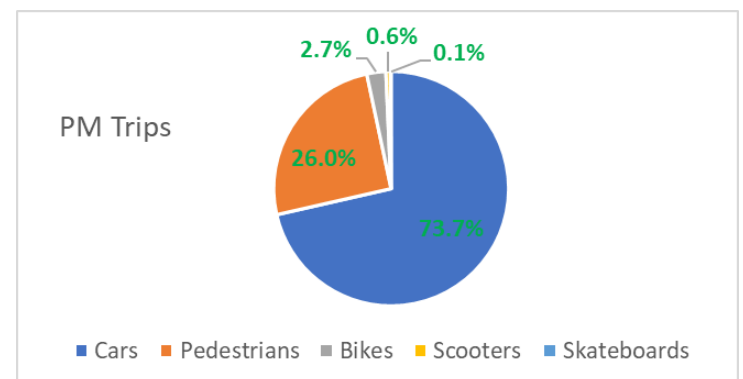
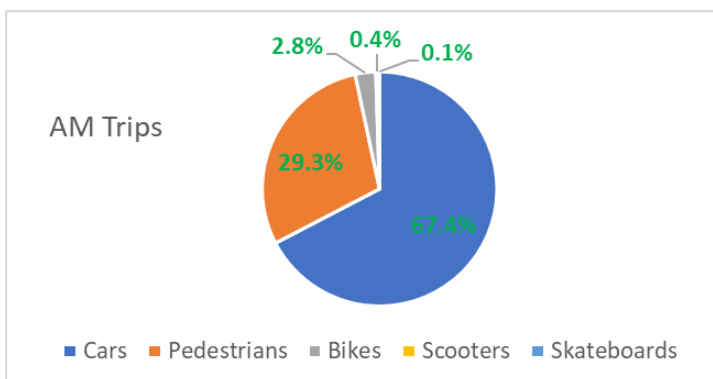

5. Regents Drive at Campus Drive

Note: No Pedestrian Access to intersection, due to construction

AM Peak Hour				
Cars	Pedestrians	Bikes	Scooters	Skateboards
636	1	80	105	0
77.4%	0.1%	9.7%	12.8%	0.0%

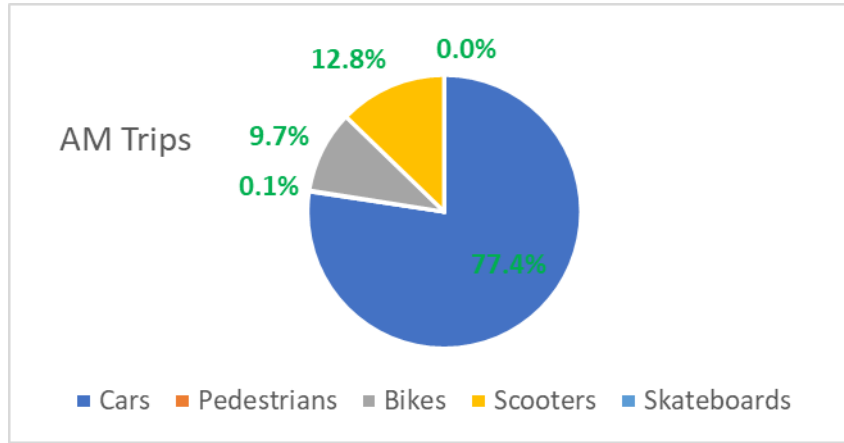

6. Regents Drive at Paint Branch Drive

AM Peak Hour				
Cars	Pedestrians	Bikes	Scooters	Skateboards
765	228	38	8	6
73.2%	21.8%	3.6%	0.8%	0.6%

PM Peak Hour				
Cars	Pedestrians	Bikes	Scooters	Skateboards
713	261	33	3	12
69.8%	25.0%	3.2%	0.3%	1.1%

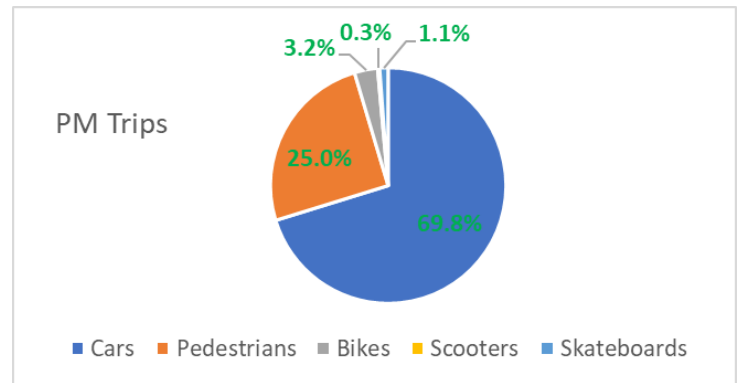
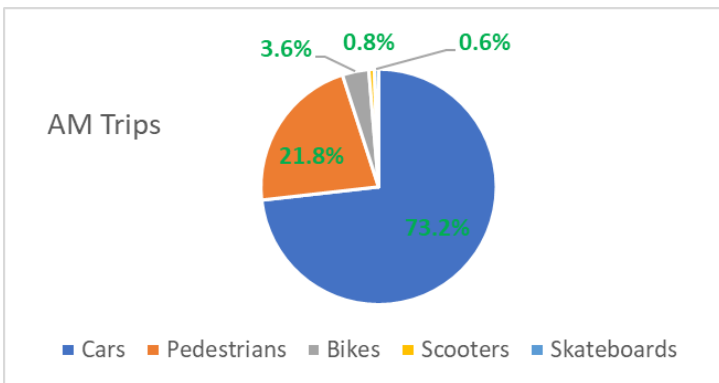

7. Stadium Drive at Regents Drive

AM Peak Hour				
Cars	Pedestrians	Bikes	Scooters	Skateboards
427	1421	58	44	1
21.9%	72.8%	3.0%	2.3%	0.1%

PM Peak Hour				
Cars	Pedestrians	Bikes	Scooters	Skateboards
513	1116	65	62	3
29.2%	57.2%	3.3%	3.2%	0.2%

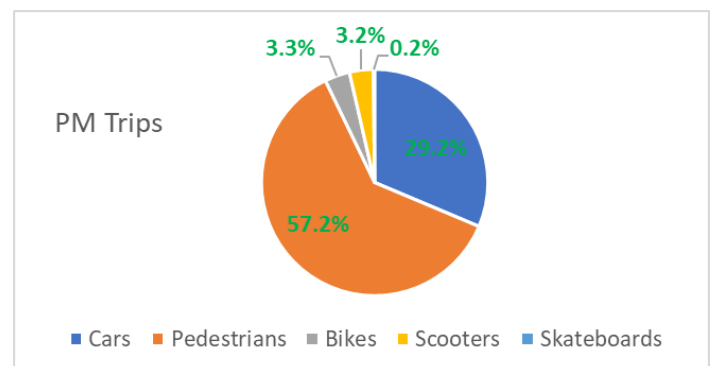
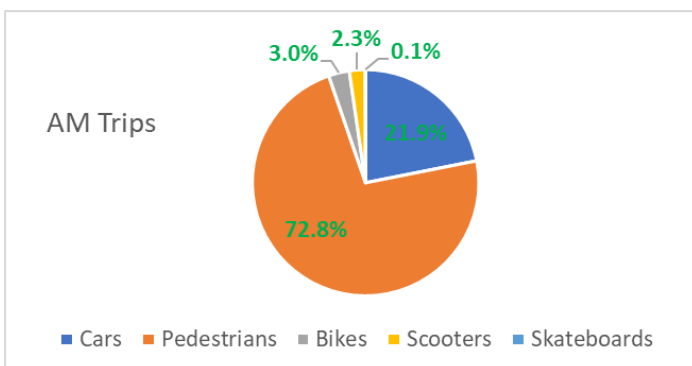



Appendix C: Mobility Audit Summary Chart

Mobility Audit Toolkit for Terps

AVERAGE SCORES

Accessibility Ratings Considered:

High Quality Sidewalks
 Safe and Convenient Crosswalks
 Accessibility Features
 Bicycle/ Scooter Facilities
 Wayfinding signage
 Pick up and Drop off zones
 Overall, the area is very easy to access and intuitive

Safety Ratings Considered:

Adequate lighting.
 Eyes-on-the-street.
 Maintenance and repair of the public realm.
 Safety buffer as your ride and roll.
 Traffic speeds and roadway courtesy.
 Safety signage.
 Overall, this area feels safe.

Behavior Ratings Considered:

Avoiding Sidewalks
 Avoiding Certain Areas
 Choosing Risky Behaviors
 Improper Bicycle or Scooter
 Parking
 Sidewalks Riding
 Hiding From Weather
 Traveling on Unmarked Pathways

Transfers Ratings Considered:

Transit Signage
 Transit Loading Areas
 Transfer Distances
 Minimized
 Overall, Transfers between transportation modes are seamless

Aesthetics Ratings Considered:

Placemaking.
 Trees and landscaping.
 Shelter and shade in waiting zones.
 Strategically placed amenities.
 Unfriendly elements are limited.
 Overall, this area's aesthetics are pleasant and welcoming

Route	Stop	Accessibility	Safety	Behaviors	Transfers	Aesthetics
South-West Campus	Architecture/Mowatt Circle	2.5	2.7	2.3	NA	1.8
South-West Campus	Business School (Van Munching Hall)	4.0	2.3	2.6	NA	3.7
North-East Campus	Chesapeake Building	2.5	3.3	2.2	2.0	2.2
North-East Campus	Lot 4J	1.9	2.3	2.5	1.0	1.3
North-East Campus	M-Circle* (only 1 observer, bonus stop)	1.0	NA	NA	NA	NA
North-East Campus	McKeldin Mall	2.3	3.5	2.1	4.0	3.8
North-East Campus	Regents	2.5	3.8	2.3	4.4	2.8
North-East Campus	Xfinity Center	1.7	3.6	2.4	1.8	2.2
North-East Campus - Average Scores per Category		2.0	3.3	2.3	2.6	2.5
South-West Campus - Average Scores per Category		3.3	2.9	2.5	2.3	2.5
Comfort Level of Participants - Average per Category		1	1	2	2	1

KEY: 1 = Disagree or Lacking 2-3 = Somewhat or Adequate 4-5 = Strongly Agree NA = No ratings, only comment

Comfort levels riding a bicycle or scooter: 1 - Strong & Fearless 2 - Enthused & Confident 3 - Interested but Concerned 4 - No way, no how